











IP55

	27 V $\overline{=}$
	20 mA
	2 x 0,35 mm ²
	-5°C / +45°C
	 PIR
	300 lux
	15 mn
	 6 m x 15 m





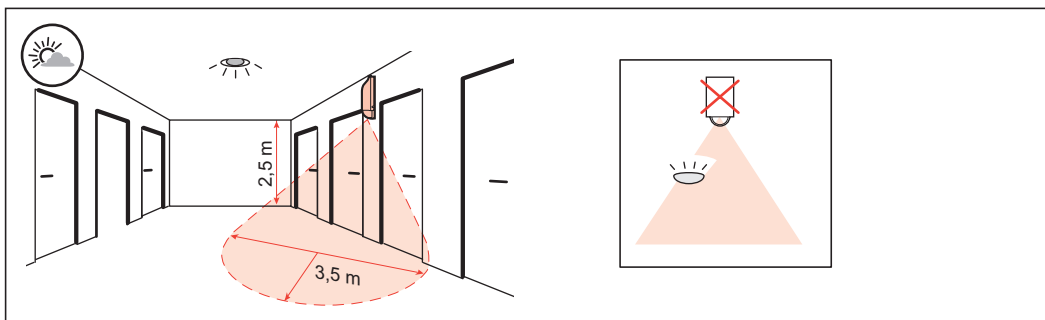
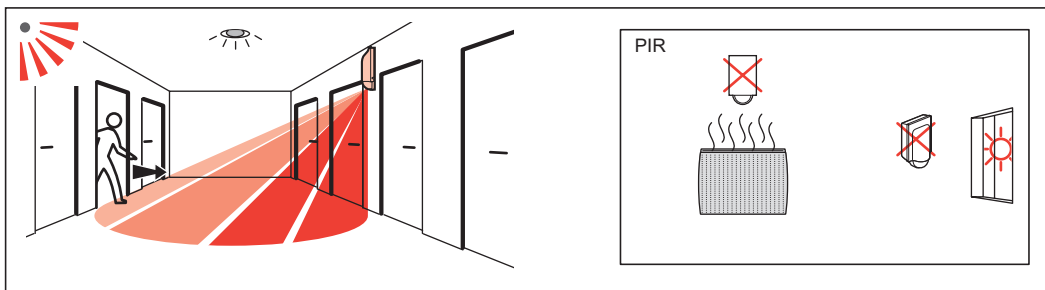
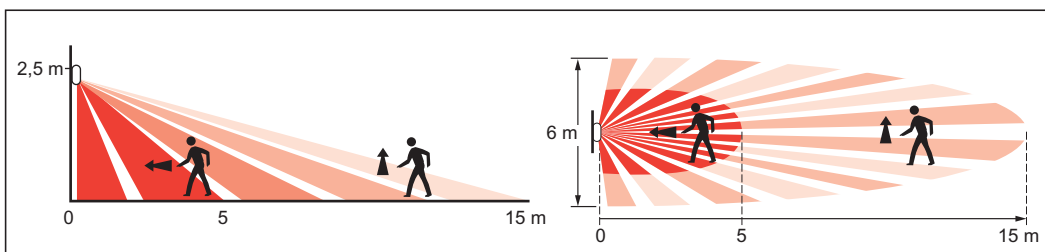
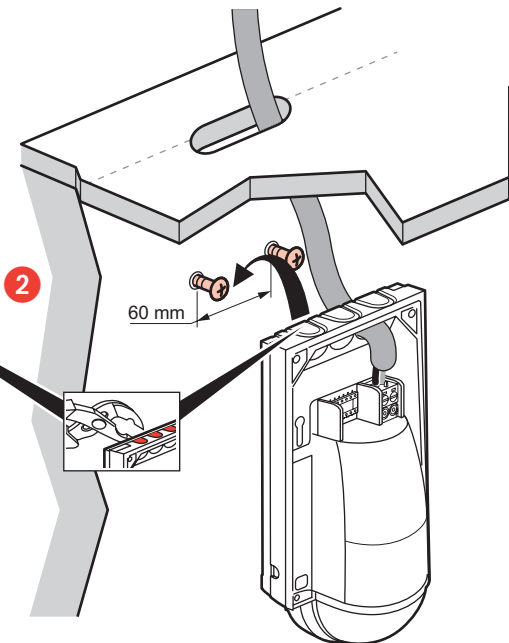
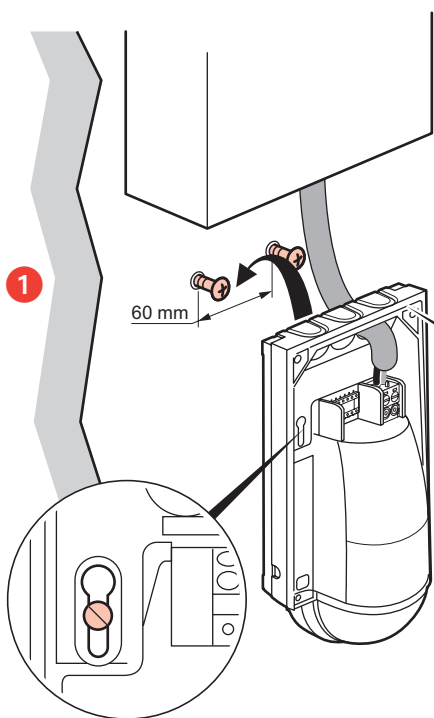
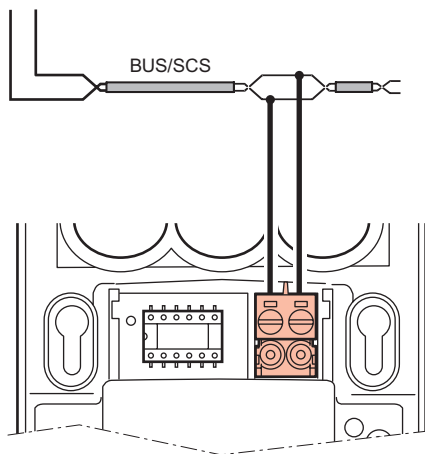
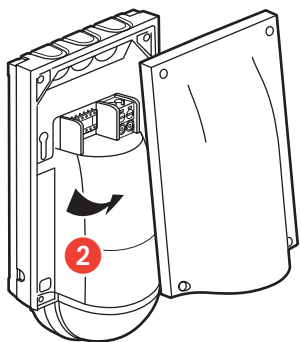
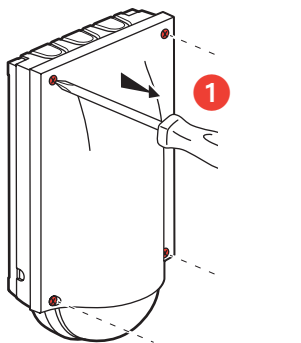
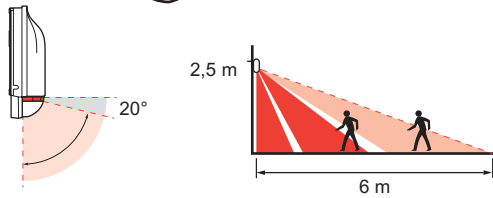
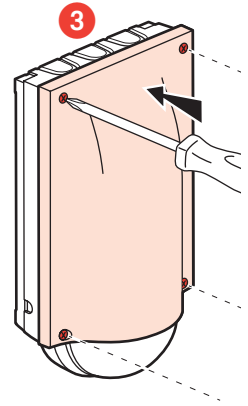
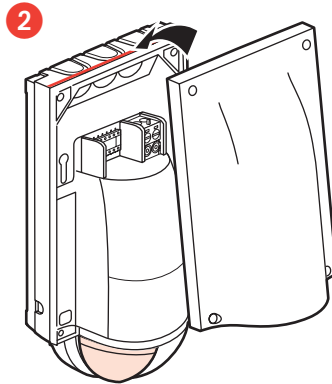
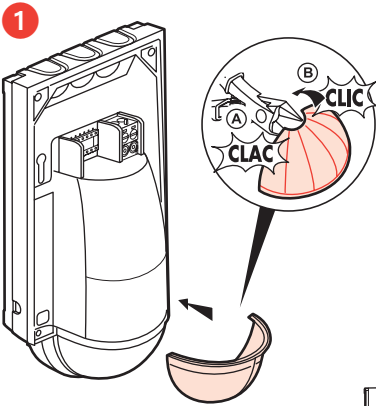
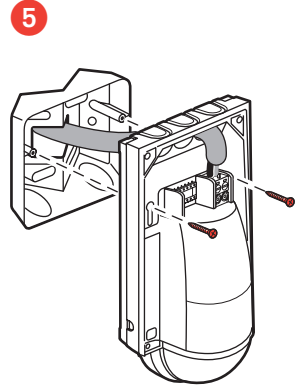
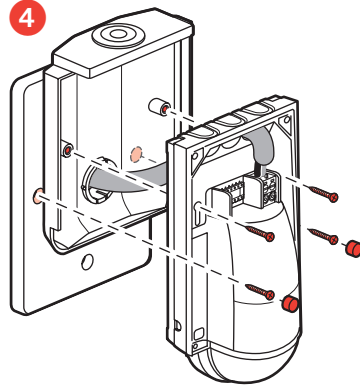
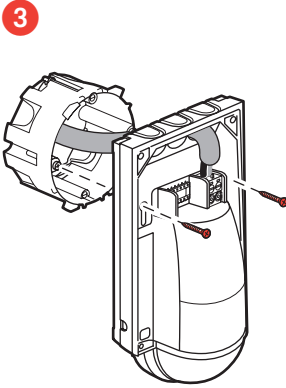
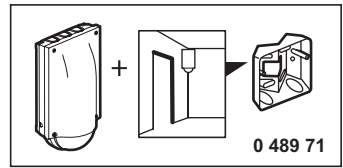
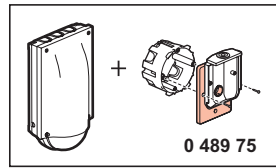
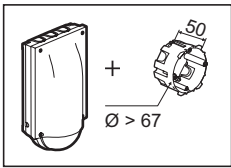



Auto ON/OFF

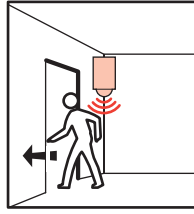
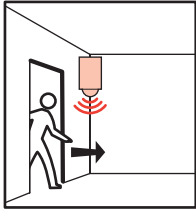

Manual ON / Auto OFF

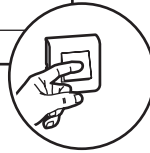
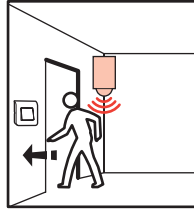

www.legrandoc.com

- Cellule de luminosité
- Daylight sensor
- Cellula di luminosità

- Capteur PIR
- PIR sensor
- Sensore PIR

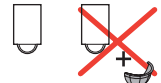
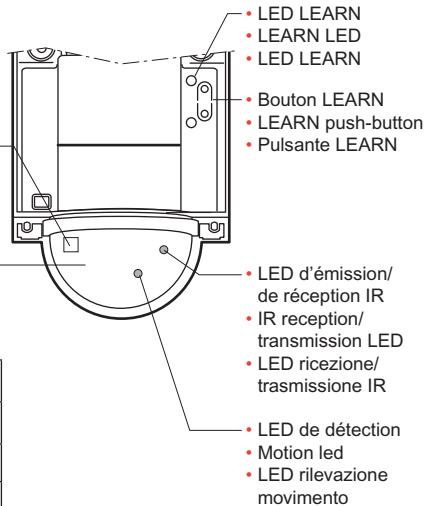

OK

NO



0 882 30
BMSO4001

	5 - 1275 lux
	30sec - 255h 59m 59s
	25 - 50 - 75 - 100 %
Mode	Auto - Manual - Walkthrough