

WORKSHOP SPECIFICATIONS

INCREASED SAFETY DISTRIBUTION SYSTEM



THE GLOBAL SPECIALIST IN ELECTRICAL
AND DIGITAL BUILDING INFRASTRUCTURES



The Service Rating - IS, defined by the French UTE C 63-429 guide, is a specification help tool which allows each specifier or user to define precisely the right level of continuity of service during the operation, maintenance and upgrading phases in an electrical panel's life. It represents the specification with which the panel must conform, as well as the level of involvement of people during these three phases. With three levels of IS distribution solutions, Legrand can satisfy the most difficult demands and offers a viable alternative to tray cabinets.

In particular, all three Legrand solutions offer the option of adding new appliances in unequipped positions without cutting the power to the panel (IS XX3), something that is impossible with conventional solutions.

WHY HAVE AN INCREASED SAFETY SYSTEM?

Interaction with forms and with
the FU withdrawability

FORMS OF SEPARATION AND WITHDRAWABILITY

The forms of separation and the types of electrical connection for Functional Units (FUs) are defined in the IEC 61439-1 and 2 standard.

The forms of separation define the barriers to be put in place to ensure a greater or lesser degree of protection against contact with dangerous parts.

The type of electrical connection for FUs expresses the technical solutions chosen in terms of whether or not the FUs can be removed (F: fixed, D: plug-in, W: draw-out) for the incoming and outgoing power circuit and the auxiliary circuits.

Both these aspects describe the technical solutions applicable to assemblies, but do not define an actual need for a safety level and maintenance time.



Legrand partitioning equipment can be used to create all forms of separation in an XL³ 4000 enclosure

THE «IS» CONCEPT

The aim of IS is to define the safety level offered by any type of low voltage distribution board during all types of intervention, in the course of the three different phases of its life: operation, maintenance, upgrading.

OPERATING THE ASSEMBLY

This consists of actions on the assembly needed during mechanical or electrical maintenance of the circuits or the installation receivers, or off-load system function tests.

The IS level determines the system's ability to separate (electrically) and/or lock out (mechanically) all or part of the installation in order to perform work or off-load system function tests on this part of the installation in total safety and with controlled consequences on its operation.

MAINTAINING THE ASSEMBLY

This consists of servicing, repair or inspection (ranging from diagnostics to replacement of faulty parts) in order to maintain the assembly's characteristics. The IS level determines the system's ability to be maintained in total safety and with controlled consequences on the installation's operation.

UPGRADING THE ASSEMBLY

This consists of operations to change the assembly by adjusting (ratings), adding or replacing components (some upgrading requires interruption of the functional unit affected: increasing the power, changing technology).

The IS level determines the system's ability to be modified in total safety and with controlled consequences on the installation's operation.

The IS, through the choice it offers, contributes to reinforcing the continuity of service and safety of the installation.

Each IS has a corresponding form level and a functional unit design in the panel (fixed, plug-in, draw-out, etc).

Although this category is not mentioned in the IEC 61439 standard series, there are undoubtedly interactions, particularly with regard to forms of separation and withdrawability index. For example, an IS X2X implies at least form 3b (see table). Separation forms take account of safety-related aspects but do not take account of the concept of upgrading the electrical panel. Conversely, the IS takes account of matters concerning locking out functional units and tests on the auxiliary circuits during all three phases of the panel's life. IS therefore goes beyond recommending forms affecting the safety of people who need to get involved in the operation, maintenance and upgrading of low voltage electrical panels.

The range of XL³ enclosures combined with Legrand distribution systems can meet all needs, from the most basic (IS 111 - form 1 - FFF withdrawability index), to the most comprehensive (IS 333 - form 4b WWW withdrawability index).

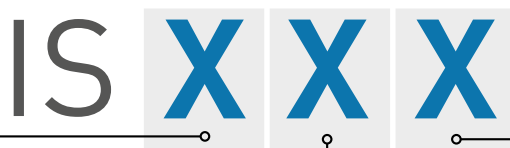

OPERATION

Determines the consequences of a mechanical lockout or electrical lockout operation on the panel to allow work on the installation

1XX

Electrical panel shuts down completely

2XX

Just the functional unit affected shuts down completely

3XX

Power shutdown of the functional unit affected, but allows control system tests to be run in order to test the installation

MAINTENANCE

Determines the capacity of the panel to be maintained in the future

X1X

Electrical panel shuts down completely

X2X

Interruption limited to just the functional unit affected for a limited time (e.g. UTE: one hour). Reinsertion will require the connections to be remade

X3X

Interruption limited to just the functional unit affected for a limited time (e.g. UTE: fifteen minutes). Reinsertion will not require the connections to be remade

UPGRADING

Determines the capacity of the panel to be upgraded in the future

XX1

Electrical panel shuts down completely

XX2

Interruption limited to just the functional unit affected. Spare functional units are provided

XX3

Addition of any type of functional unit in an unequipped slot, without switching off the panel

CORRESPONDENCE BETWEEN THE IS AND THE TYPE OF TECHNICAL SOLUTION TO BE INSTALLED

MINIMUM IS REQUIRED	MINIMUM FORM OF SEPARATION	MINIMUM WITHDRAWABILITY INDEX	PROPOSED LEGRAND SOLUTION	IS ACHIEVED	MAXIMUM FORM WITH LEGRAND SOLUTION	LEGRAND WITHDRAWABILITY INDEX
111	1	FFF	Fixed versions ²	111	4b	FFF
211	1	FFF	IS 223	223	4b ³	DFF/DFD
221	3b	DFF		223	4b ³	DFF/DFD
222	3b	DFF		223	4b ³	DFF/DFD
223	3b	DFF		223	4b ³	DFF/DFD
231	3b	DDD	IS 233	233	4b	DDD
232	3b	DDD	IS 233	233	4b	DDD
233	3b	DDD	IS 233	233	4b	DDD
311	1	WWW	IS 333	333	4b	WWW
321	3b	WWW	IS 333	333	4b	WWW
322	3b	WWW	IS 333	333	4b	WWW
323	3b	WWW	IS 333	333	4b	WWW
331	3b	WWW	IS 333	333	4b	WWW
332	3b	WWW	IS 333	333	4b	WWW
333	3b	WWW	IS 333	333	4b	WWW

2: With door-mounted rotary handle for main device

3: Using external terminals (see page 33)

LEGRAND SOLUTIONS

Introduction to the range

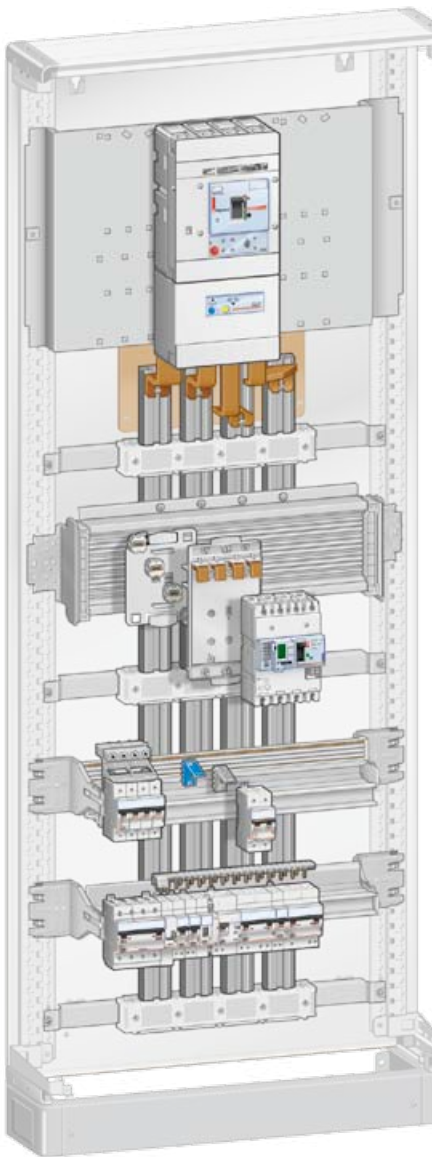

Tinned and copper-plated aluminium C-section bars at the back of the enclosure supplied by a DPX circuit breaker with a prefabricated power supply kit.

UP TO IS 223 : OPTIMISED ROW DISTRIBUTION

Optimised distribution provides a complete, coherent system for creating a low voltage electrical panel.

The system consists of:

- optimised busbars
- prefabricated links
- distribution blocks adapted to specific appliances
- distribution via supply busbars for modular devices

All these components, which have been tested with Legrand wiring accessories, can be used to build safe panels that comply with standard IEC 61439, reduce installation time and optimise the size of the enclosures.



HX³ 125 A PLUG-IN SYSTEM HORIZONTAL DISTRIBUTION BLOCK

Upstream connection/disconnection of DX³ modular devices totally safely, even when the distribution block is powered-up [circuit breaker open: circuit off-load].

Enclosures equipped with this system provide IP xxB protection because the live parts cannot be accessed without special tools.

This optimised distribution system is of course available in the majority of enclosures in the XL³ range, making it suitable for all projects from the XL³ 160 secondary distribution board to the installation main LV distribution board in XL³ 4000.

Some optimised distribution systems even offer the possibility of connection while powered-up. In fact the combination of HX³ - IP xxB distribution blocks with the new snap-in connection system means products can be added or removed with the voltage present without doing anything to the upstream connections.

 With HX³ 125 plug, HX³ 250 and HX³ 400 distribution blocks, the increased safety levels in rows can effectively be raised to level IS 223.



HX³ IS 250/400 A ROW DISTRIBUTION BLOCKS

This allows upstream connection/disconnection with the voltage present (circuit breaker open: circuit off-load) and the mix of DX³ and DPX³ circuit breakers.

IS 223 ROW DISTRIBUTION IN XL³ ENCLOSURES

ROW DISTRIBUTION BLOCKS	ENCLOSURES			
	XL ³ 160	XL ³ 400	XL ³ 800	XL ³ 4000
HX ³ 125 plug-in connection	•	•	•	•
HX ³ 250		•		
HX ³ 400			•	•

CIRCUIT BREAKERS WHICH ARE MOUNTED ON HX³ DISTRIBUTION BLOCKS

CIRCUIT BREAKERS	ROW DISTRIBUTION BLOCKS			
	HX ³ 125 PLUG-IN	HX ³ 250	HX ³ 400	
DX ³	1P+N RCBOs – protection of outgoing lines	•	•	•
	2P and 4P RCCBs – protection of outgoing lines	•	•	•
	2P and 4P RCBOs – protection of outgoing lines	•	•	•
	1P, 2P, 3P and 4P circuit breakers – 1 module/pole	•	•	•
	1P, 2P, 3P and 4P circuit breakers – 1.5 modules/pole		• 1	• 1
DPX ³	3P and 4P MCCBs with or without residual current protection		•	•

1: With wired bases only

UP TO IS 333: INCREASED SAFETY (IS) DISTRIBUTION SYSTEM

The VX³ IS increased safety distribution system consists of a column chassis which can be equipped with either 1250 or 2000 A tinned and copper-plated aluminium bars, and removable bases, allowing functional units (up to 630 A) to be connected to it. The column chassis is common to all IS XX3.

COMPOSITION OF THE VX³ IS COLUMN CHASSIS

The column chassis is specific to XL³ 4000 enclosures with an outer height of 2200 mm and is available under two catalogue numbers depending on the enclosure depth:

- Cat.No 4 046 00 for mounting in 725 mm deep enclosures
- Cat.No 4 046 02 for mounting in 975 mm deep enclosures



The large items making up the VX³ IS column chassis Cat.No 4 046 00 and Cat.No 4 046 02 are supplied flat on a pallet in order to avoid damages during transportation.

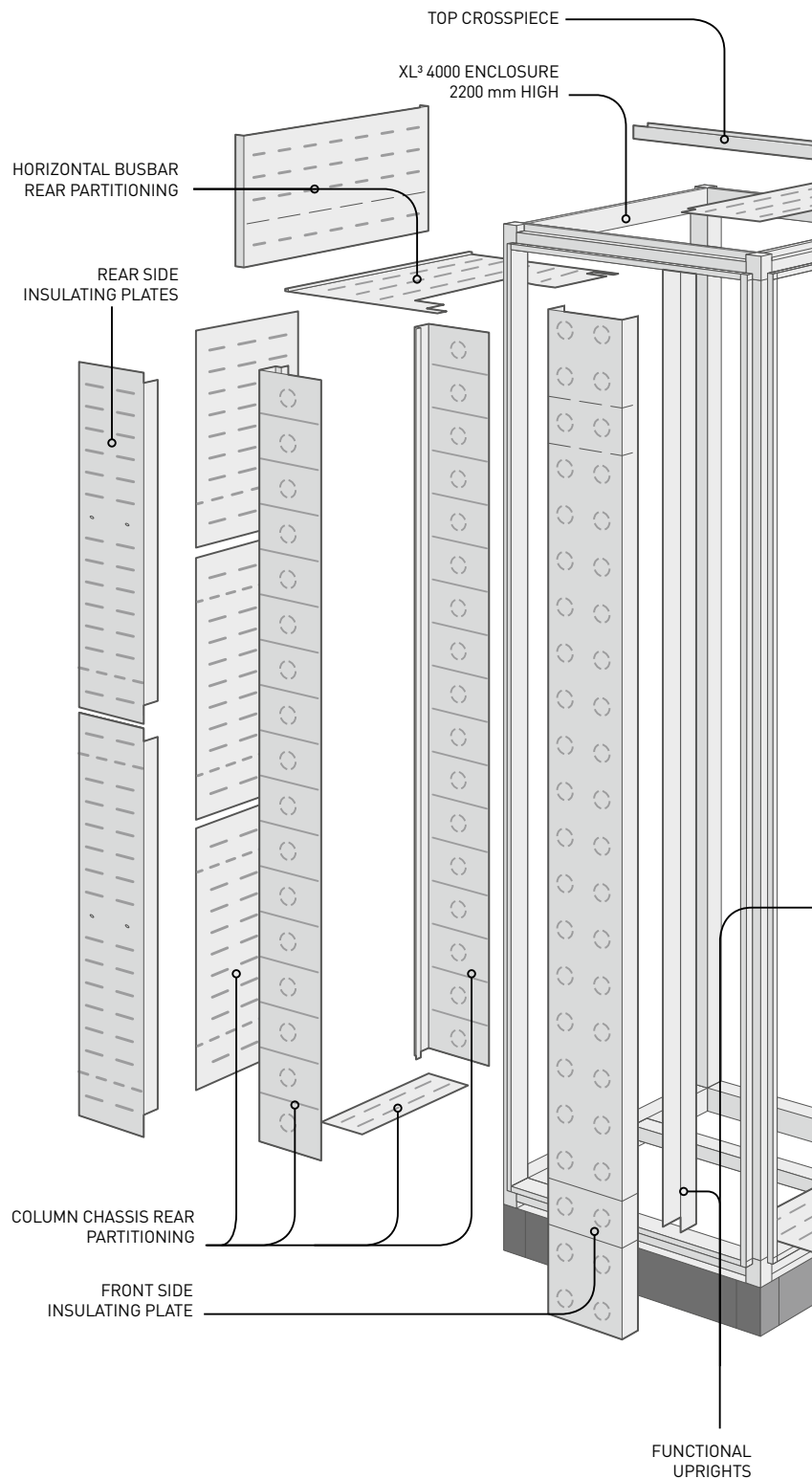

The column chassis consists of all the items used to fix and protect busbars in the enclosure:

- isolating supports
- functional uprights for fixing the bases
- intermediate upright and crosspieces for fixing the isolating supports
- busbar protection insulating strips
- all the dividers needed to obtain form 4a in IS 223 (2b in IS 233/333)

i The faceplate support frame is not supplied with the column chassis because it should not be used for IS 333. Two faceplate support frames can be used for IS 223 and 233, Cat.No 0 208 55 for enclosures 725 mm or 975 mm wide without internal cable sleeve and Cat.No 0 208 56 for enclosures 975 mm wide with internal cable sleeve.

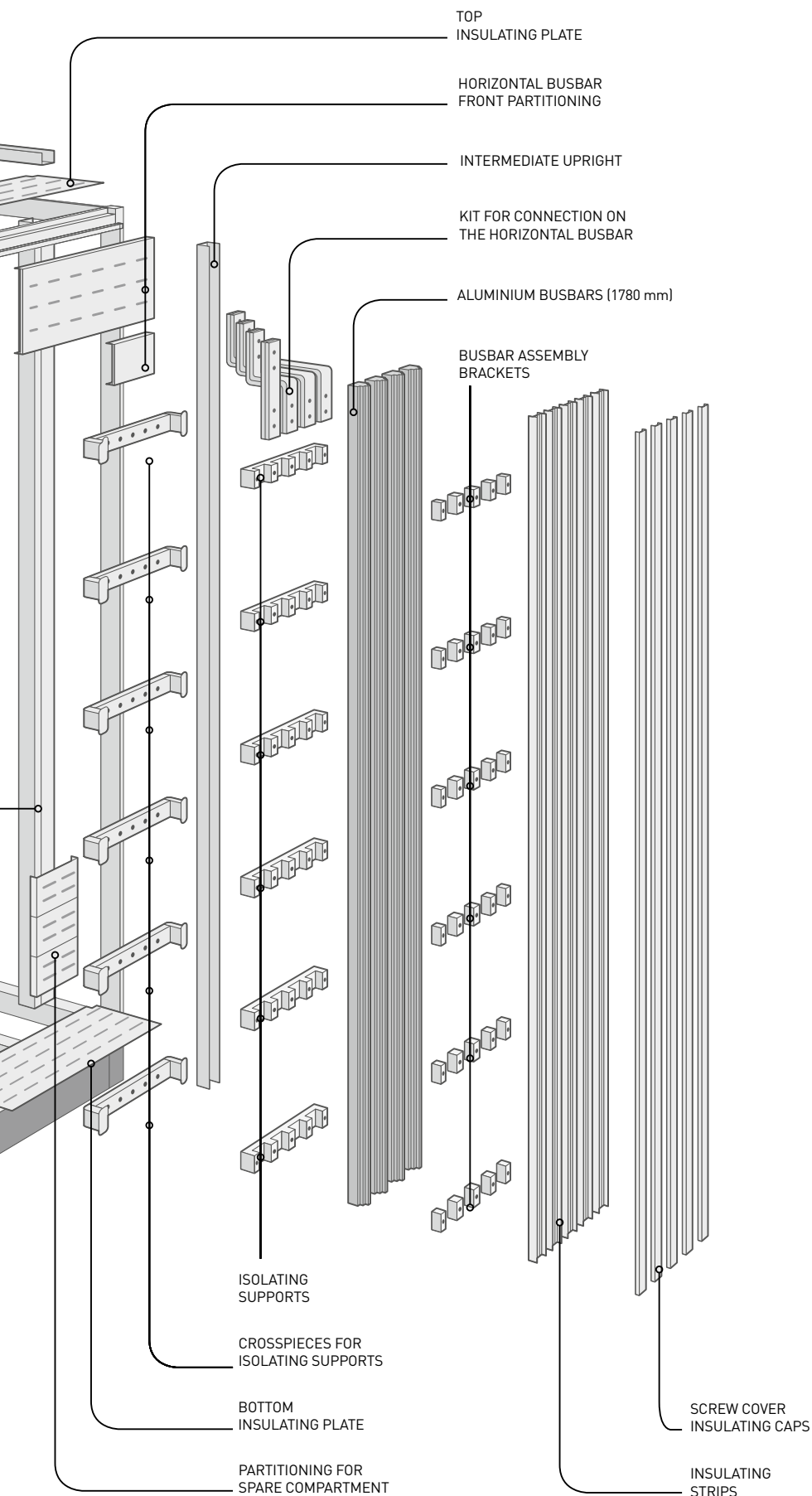

There are six isolating supports, as is required for an Icw of 70 kA.

FORMS OF SEPARATION POSSIBLE WITH THE IS SYSTEM

Forms of separation up to 4b can be created with the VX³ IS increased safety distribution system. Depending on the IS level required it may be necessary to add one or more catalogue numbers to the forms supplied with the column chassis (see page 15).



The spare compartments guarantee 3b form, required for IS 223, 233 and 333.



The use of partitioning compartments for downstream connections in IS 233/333 allow obtaining 4b form.

IS 223 ROW DISTRIBUTION BLOCKS

The IS row distribution blocks act as the interface between the VX3 IS column chassis and a row of appliances. One row can be made up of :

- modular devices only, which is the case for the HX³ IS 125 A row distribution block
- a mixture of 1 module / 1.5 modules per pole modular devices and DPX³ MCCBs, which is the case for the HX³ IS 400 A row distribution block.

The row distribution blocks come in two parts:

- the fixed part, which is connected to the column chassis bars by means of snap-on grippers allowing connection/disconnection with the voltage present
- the movable part on which protection devices are mounted. This is very easily connected/disconnected from the fixed part. It is locked with ¼ turn screws.

The HX³ IS row distribution block can be upgraded with the voltage present (IS XX3) for either the complete row, or for individual appliances, after making sure that the appliances are in the "open" position.



HX³ IS 400 A ROW DISTRIBUTION BLOCK (300 mm high)

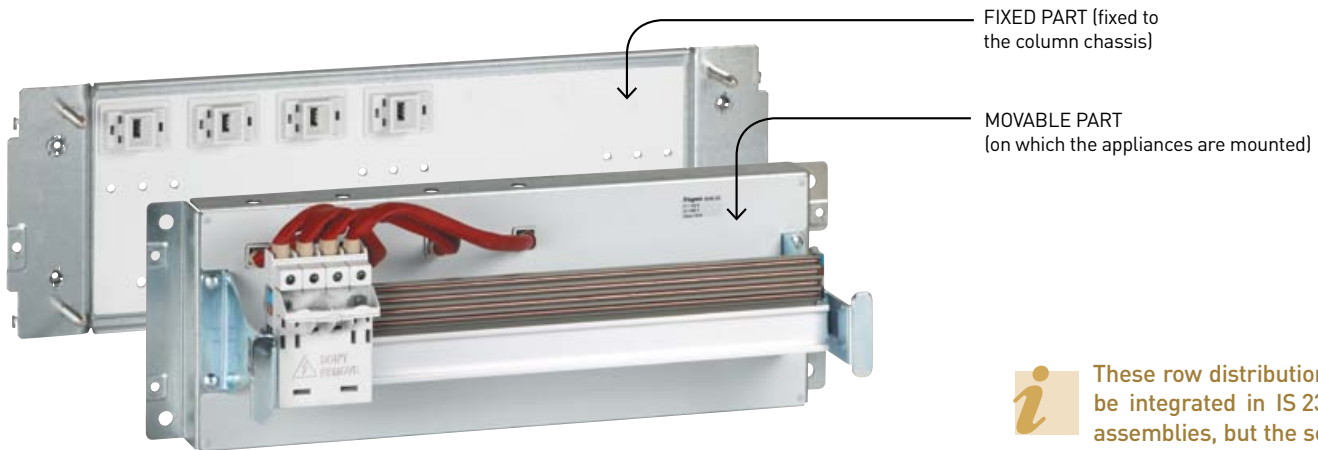

HX³ IS 125 A ROW DISTRIBUTION BLOCK

i These row distribution blocks can be integrated in IS 233 and 333 assemblies, but the service rating of the concerned rows will still be IS 223.

VX³ IS BASES FOR DPX/DPX³ MCCBs (IS 223/233/333)

These bases act as an interface between the column chassis and the functional units.

They can take DPX³ 160 and 250 and DPX 630 (3P or 4P versions) with or without residual current protection. The circuit breakers can be used without accessories or fitted with rotary handles or motor-driven controls. Two faceplate types are therefore available depending on which configuration is chosen.

The bases come in two parts:

- The fixed part which is connected to the column chassis bars by means of snap-on grippers allowing connection/disconnection with the voltage present.
- The movable part on which the circuit breaker is mounted, which is very easily connected/disconnected from the fixed part. It is very quick to lock with ¼ turn screws.

Each base can be equipped with a terminal block for connecting the auxiliary circuits. This terminal block is used to connect/disconnect these circuits automatically when inserting and removing the movable part. IS 333 bases are supplied already fitted with the terminal block.



CONNECTOR BLOCK FOR THE AUXILIARY CIRCUITS

IS 223 BASES

Upstream connection : the circuit breaker is automatically connected to the column chassis via the base grippers.

Downstream connection : the circuit breaker is directly connected by the means of its own connection plates.

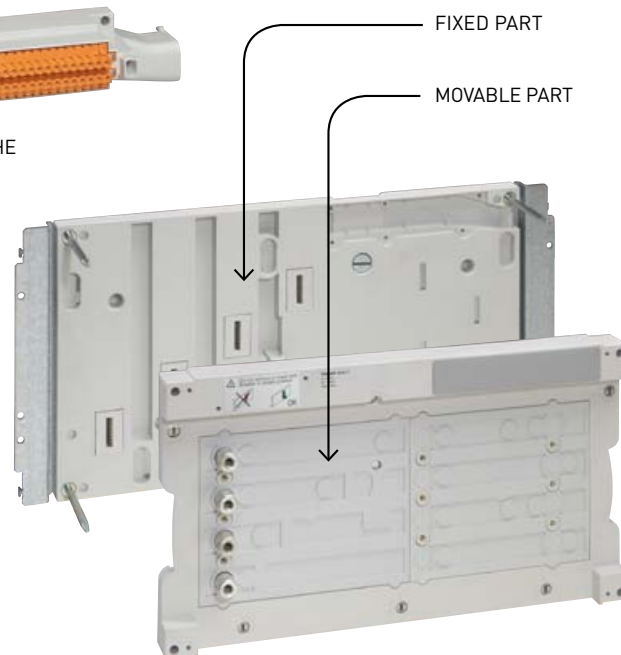

IS 223 BASE FOR DPX 630



DPX and DPX³ circuit breakers are mounted horizontally on the bases.



Simplicity and speed of installation - a functional unit can be added or replaced in less than an hour. These operations are performed without having to cut the power to the column chassis.

BASES FOR IS 233

Upstream connection : the circuit breaker is automatically connected to the column chassis via the base grippers.
 Downstream connection : on bar ends at the rear of the base (fixed part).



BASES FOR IS 333

Upstream connection : the circuit breaker is automatically connected to the column chassis via the base grippers.
 Downstream connection : on bar ends at the rear of the base (fixed part). The auxiliary circuits are connected via the automatic connector block.

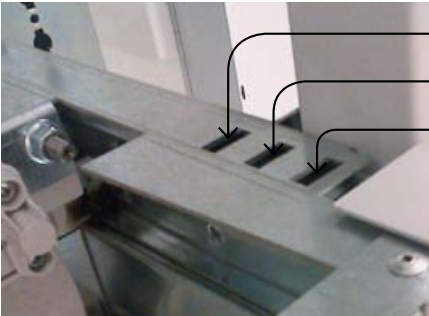

"DRAWN-OUT" POSITION
 "TEST" POSITION
 "PLUGGED-IN" POSITION



The tray position is indicated by a coloured LED and can be locked out with a padlock.



IS 333 BASE IN "DRAWN-OUT" POSITION

+ **+** Straightforward connection. Simplicity and speed of installation - a functional unit can be added or replaced in less than quarter of an hour.

+ **+** The same applies to the IS 233 with the possibility of testing the auxiliary circuits off-load thanks to the test position. All three positions on the movable base are stable and can be locked out.

UNIVERSAL BASES

There are three of these, all 300 mm high, which should be selected according to required IS level.



UNIVERSAL BASE FOR IS 233

Installation is similar to that for bases for MCCBs.

The movable base is covered with a solid sheet steel plate on which any appliance up to 630 A can be fixed.

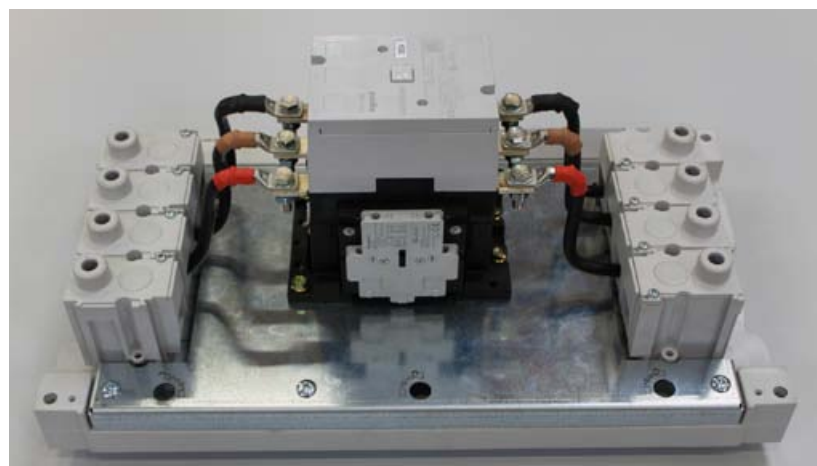

EXAMPLE OF A CONTACTOR FOR MOTOR STARTER MOUNTED ON A UNIVERSAL BASE

THE VX³ IS COLUMN CHASSIS

The VX³ IS column chassis is common to all increased safety levels in the range (IS 223, IS 233, IS 333). It constitutes the backbone of the distribution system. Equipped with copper-plated and tinned aluminium bars 1780 mm long, it is intended to be mounted in XL³ 4000 enclosures with an outer height of 2200 mm.



+ **+** The aluminium bars are copper-plated and tinned by a patented treatment which guarantees electrochemical compatibility with copper or aluminium bars and lugs.

PRODUCT SELECTION

IS 223 AND IS 233

Three catalogue numbers must be selected to create the column chassis.

1 - Copper-plated and tinned aluminium bars

Selected according to the operating current.

Max. In (A)	Cat.No
1250	4 046 04
2000	4 046 06

2 - Uprights and supports

Selected according to the depth of the enclosure.

For XL ³ 4000 depth (mm)	Cat.No
725	4 046 00
975	4 046 02

These catalogue items include all the items used to fix and protect busbars in the enclosure:

- isolating supports
- functional uprights for fixing the bases
- intermediate upright and crosspieces for fixing the isolating supports
- busbar protection insulating strips
- all the dividers needed to obtain form 3b and 4a in IS 223 and form 2b in IS 233 (minimum form level achieved with the IS system)

3 - Faceplate support frames

Selected according to the width of the enclosure.

For XL ³ 4000 width (mm)	Cat.No
725	0 208 55
975*	0 208 56

*With internal cable sleeve



The faceplate support is only needed for IS 223 and 233.

**IS 223/233 column chassis
3 catalogue numbers**

Aluminium busbars

+

Uprights & supports

+

Faceplate support frame

IS 333

Two catalogue numbers must be selected to create the column chassis.

1 - Copper-plated and tinned aluminium bars

Selected according to the operating current.

Max. In (A)	Cat.No
1250	4 046 04
2000	4 046 06

2 - Uprights and supports

Selected according to the depth of the enclosure.

For XL ³ 4000 depth (mm)	Cat.No
725	4 046 00
975	4 046 02

These catalogue numbers include all the items used to fix and protect busbars in the enclosure:

- isolating supports
- functional uprights for fixing the bases
- intermediate upright and crosspieces for fixing the isolating supports
- busbar protection insulating strips
- all the dividers needed to obtain form 2b (minimum form level achieved with the IS system)

IS 333 column chassis
2 catalogue numbers
Aluminium busbars
+
Uprights & supports

Faceplate support frames should not be used for IS 333 since a special faceplate can be mounted on VX³ IS 333 bases. To mount standard screw-mounting faceplates in free slots in the IS 333 chassis, it is necessary to use fixing lugs Cat.No 4 046 79.



FIXING LUGS CAT.NO 4 046 79

ADDITIONAL PARTITIONS FOR FORMS OF SEPARATION

Forms of separation up to 4b can be created with the VX³ IS "increased safety" distribution system. Depending on the IS level required it may be necessary to add one or more of the following five catalogue numbers to the forms supplied with the column chassis:

- Cat.No 4 046 85: partitioning kit for horizontal busbar in internal cable sleeve
- Cat.No 4 046 86: partitioning kit for horizontal busbar in external cable sleeve
- Cat.No 4 046 87: IS 233/333 rear partitioning kit, 200 mm high
- Cat.No 4 046 88: IS 233/333 rear partitioning kit, 300 mm high
- Cat.No 4 046 89: partitioning 300 mm high for spare compartment

Installation	IS 223	IS 233 IS 333
IS chassis only without spare compartment ¹	Form 3b/4a	-
IS chassis with spare compartments Cat.No 4 046 89	-	Form 3b
IS chassis with rear partitioning compartments Cat.Nos 4 046 87/88	-	Form 4b

¹: If necessary, use partitions for horizontal busbars in internal/external cable sleeves Cat. Nos. 4 046 85/86

THE VX³ IS COLUMN CHASSIS

IMPLEMENTATION

Example of mounting a VX³ IS column chassis, with the outgoing lines on the right and the horizontal main busbar at the top, in an XL³ 4000 enclosure 725 mm wide and 975 mm deep.

1 MOUNTING THE TOP AND BOTTOM CROSSPIECES



Place the top and bottom fixing lugs 375 mm from the left-hand side of the enclosure.

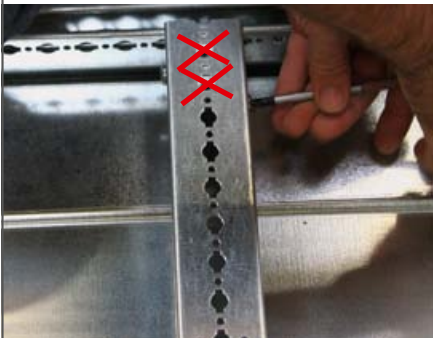

Insert the crosspiece and secure it to the lugs with the screws supplied.

 Do not use the holes on top of the crosspiece.

2 MOUNTING THE VERTICAL UPRIGHT

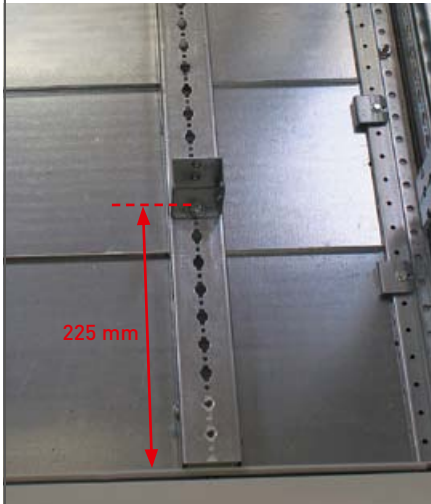

Screw the upright fixing lugs to the top and bottom crosspieces (225 mm from the front of the enclosure).



Place the upright and screw it to the fixing lugs using the screws supplied (use the holes on the sides of the upright).

3 MOUNTING THE FUNCTIONAL UPRIGHTS AND THE FACEPLATE SUPPORT FRAME

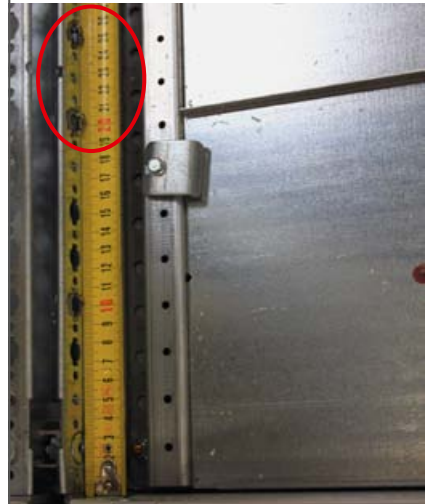

To secure the functional uprights, insert the clip-nuts 200 and 250 mm from the front.



The faceplate support uprights are fixed in the first tapped hole 50 mm from the front (below the earth symbol).



 The busbar can be mounted on either the left or right of the enclosure.

In the example opposite, mounting 2 column chassis the other way round means that all the outgoing lines can be positioned in the middle of the panel.

4 MOUNTING THE BUSBAR SUPPORTS



TOP AND BOTTOM SUPPORTS



INTERMEDIATE SUPPORT (X 4)

The column chassis consists of six busbar supports, including two different supports at the ends.

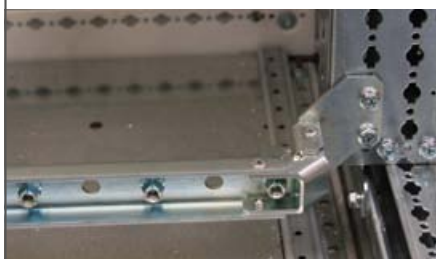

The bottom end support is fixed at the back of the lower part of the functional uprights (use the first two holes).



Intermediate supports are then fixed every 300 mm (tightening torque: 15 N·m).



Rear view of the column chassis with the supports in place.



The insulators simply clip on the metal supports.



The bottom support takes the busbar end stops, which slide into a groove in the insulator.

5 MOUNTING AND FIXING BUSBARS



Each support needs five flanges. There are two sorts:
 - the two side flanges
 - the three middle flanges

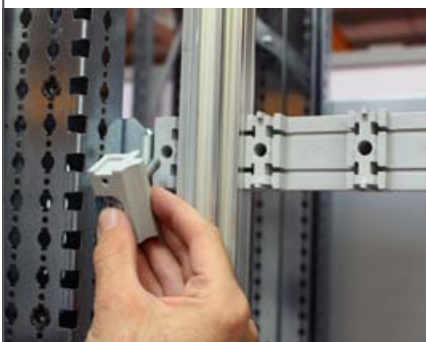

The busbars are engaged in the isolating supports. Flanges screwed into the supports hold the busbars in position.



The flanges ensure the mechanical strength of the busbars on the chassis (tightening torque: 20 N·m).

THE VX³ IS COLUMN CHASSIS

6 MOUNTING THE BUSBAR INSULATING STRIPS



There are five insulating strips, and only the strip on the right-hand side (next to the vertical upright) differs from the others.



The insulating strips are first inserted in the lug support guides. They are then clipped onto the busbars starting at the bottom, exerting pressure on the sides.



Insulating strips and caps provide the column chassis with IP XXB protection (impossible to access live parts).



The strips are finally secured with four rows of five screws fixed on the flanges (tightening torque: 1 N·m).



To hide the screws, the insulating strips are covered with a protection cover, which simply clips on.

7 MOUNTING THE TOP AND BOTTOM DIVIDERS



The top and bottom dividers are screwed onto brackets (two at the top and two at the bottom). These are fixed on the structural uprights 100 mm from the front of the enclosure.

8 UPSTREAM CONNECTION

The column chassis is connected to the main busbar very simply, using four prefabricated kits.

Column chassis power supply kits

Horizontal busbar		Column chassis bars	Kit Cat.No
Bars	In		
Copper (125 mm fixing centres)	4000 A	1250 A	4 046 90
	6300 A	2000 A	4 046 91
Aluminium (75 mm fixing centres)	1600 A	1250 A	4 046 92
	3200 A	2000 A	4 046 93

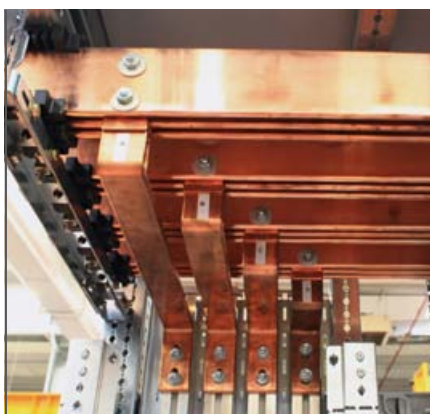

Mounting connection kit Cat.No 4 046 91.

Tightening torques:

- on aluminium bars: 50 N · m
- on copper bars: 40 to 50 N · m

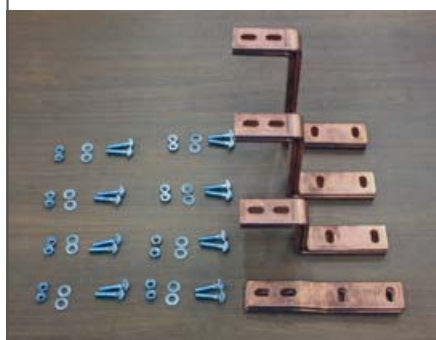

The prefabricated connection kits consist of angled, drilled bars and their mounting screws.



Mounting connection kit Cat.No 4 046 93.

Tightening torque: 50 N · m



The main horizontal busbar can be positioned at the bottom of the enclosure



Example of horizontal busbar at the bottom of the enclosure with access cover created by the panel builder for checking the fish-plating.

THE COLUMN CHASSIS

9 MOUNTING THE PARTITIONING FOR THE TOP OR BOTTOM HORIZONTAL BUSBAR (SAME AS FOR CABLE SLEEVE)

Before installing the horizontal partitioning for the main busbar, the chassis power supply kit should be installed (see "Upstream connection" paragraph).

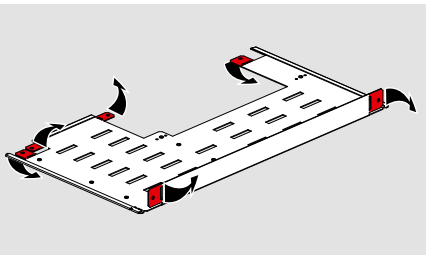

The horizontal insulating plate fixing lugs must be folded back prior to insertion.

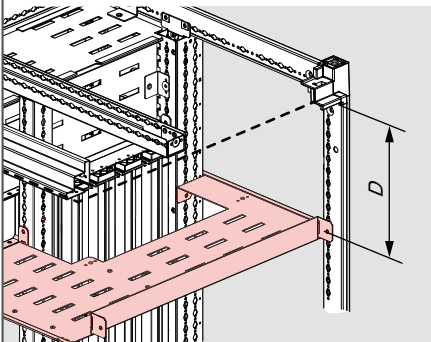

Horizontal busbar	Distance D (mm)	Faceplate height (mm)
≤ 1600 A	175	200
≤ 4000 A	275	300
≤ 6300 A	375	400



Don't forget to fix the busbar identification plate at the top of the chassis.



The divider for the horizontal busbar must be completed with a backplate. This divider is supplied for 400 mm high partitioning but can be adapted to 200 or 300 mm.



Similarly, for the front of the enclosure, a 200 mm plate is provided. Depending on the height of the busbar, one or two 100 mm additional elements can be added on the right-hand side of the column chassis.

10 MOUNTING THE CHASSIS REAR PARTITIONING

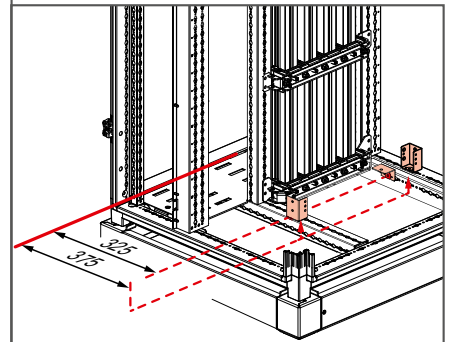
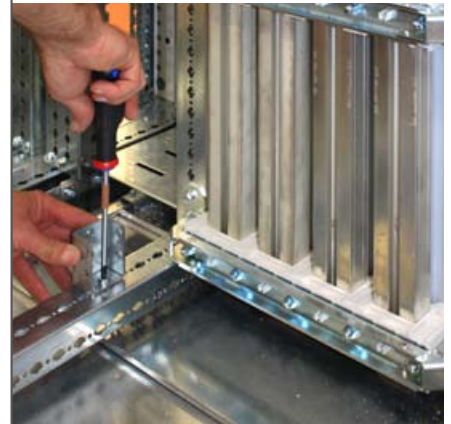

The fixing lugs for the IS chassis rear partitioning are fixed to the enclosure upper and lower crosspieces with a middle screw positioned 375 mm from the front.



Also fix the four brackets for the top and bottom cover plates 325 mm from the front.

11 MOUNTING OPTIONAL SPARE COMPARTMENTS



The top and bottom cover plates are screwed onto brackets before the side partitions are inserted.



Fix the side partitions on the four previously installed lugs.



The cover plates are manipulated with a removable handle supplied in the kit. They are screwed onto the side partitions.



The same applies to the rear side insulating plates.



Now simply fix the two front side insulating plates on the column chassis uprights.

! If the chassis is intended to take IS 333 bases, the faceplate support frame should not be used. For spare compartments, this is replaced with fixing lugs for standard screw-mounting faceplates Cat.No 4 046 79. The front panel side partitioning is then complete.



To obtain form level 3b, the part of the IS chassis not equipped with the VX³ IS base must be closed at the front with 300 mm high spare compartments Cat.No 4 046 89. If necessary, they can be cut at 100 mm intervals.

FORMS

The IS distribution system can obtain the minimum form level 3b (with spare compartments for IS 233 and 333) and can easily be upgraded to level 4b in IS 233 and 333 with the use of rear compartments.

IS 223

DISTRIBUTION BLOCKS AND BASES

IS 223 row distribution blocks and bases combined with the column chassis can be used to create an IS 223 enclosure very quickly, meaning that:

■ **During operation**

Each circuit can be controlled independently of the others. It is not possible, however, to test the auxiliary circuits of a disconnected functional unit (FU).

■ **During maintenance**

It is possible to replace an FU without disconnecting the other circuits in the enclosure. However, any equipment connected upstream must be switched off.

■ **During upgrading**

It is possible to add any type of FU (single appliance or rows of appliances) in an unequipped slot.

To do this, IS 223 distribution blocks and bases are equipped with an automatic connection system for connecting equipment upstream of the main circuit.



PRODUCT SELECTION



HX³ IS 125 A DISTRIBUTION BLOCK

HX³ IS 223 125 A row distribution block Cat.No 4 046 68 is exclusively installed in XL³ 4000 enclosures on functional uprights supplied with the IS chassis. It takes DX³ modular devices equipped with connection modules.

These modules enable connection and disconnection of the MCBs on the row distribution block, without using any special tools. They are supplied by packs of ten modules of the same type. Each type is connected to a different phase of the distribution block and is identified by its colour.



CONNECTION MODULES
CAT.NO 4 052 43/44/45/46

Compatible modular devices	Connection modules
2P and 4P DX³-ID RCCBs – incoming via the top/outgoing via the bottom	4 052 43 (L1) 4 052 44 (L2)
2P and 4P DX³ RCBOs – protection of outgoing lines	4 052 45 (L3)
1P, 2P, 3P and 4P DX³ circuit breakers – 1 module/pole	4 056 46 (N)



HX³ IS 400 A DISTRIBUTION BLOCK

The HX³ IS 400 A row distribution block is exclusively installed in XL³ 4000 enclosures on functional uprights supplied with the IS chassis. They take the support bases for mounting DPX³ and for modular devices.

■ Support bases for DPX³

The four standard catalogue numbers for DPX³ allow automatic connection of 3P and 4P versions of the DPX³ 160 and DPX³ 250 A circuit breakers.

Support bases for DPX³		
Appliance	DPX³ 160	DPX³ 250
3P	4 045 00	4 045 02
4P	4 045 01	4 045 03



Support bases for DPX³ are made up of two parts:
 - a snap-fit base which attaches to the distribution block
 - a movable support to which the DPX³ is attached, which plugs into the fixed part

■ Plug-in bases for DX³

Plug-in (wireless) bases for DX³ are intended for devices with 1 module per pole which are connected via the rear of the circuit breaker.

Plug-in bases for DX³		
Appliance	Connection	1 mod./pole
1P	L1	4 045 10
	L2	4 045 11
	L3	4 045 12
	N	4 045 13
3P	L1, L2, L3	4 045 09
4P	L1, L2, L3, N	4 045 08



■ Wired bases for DX³

This type of base is used to connect modular devices with screw terminals and either 1 or 1.5 modules per pole depending on the catalogue number chosen.

Wired bases for DX³			
Appliance	Connection	1 mod./pole	1.5 mod./pole
1P	L1	4 045 18	4 045 24
	L2	4 045 19	4 045 25
	L3	4 045 20	4 045 26
	N	4 045 17	4 045 23
3P	L1, L2, L3	4 045 16	4 045 22
4P	L1, L2, L3, N	4 045 15	4 045 21



■ Universal modular base

Base Cat.No 4 045 27 is a support 1 module wide, without connections. It is used for mounting any modular device on the HX³ IS 400 A row distribution block (control signalling, auxiliary, etc).



DX³ appliances compatible with modular bases		
Appliances	Plug-in bases	Wired bases
2P and 4P DX³ -ID RCCBs – outgoing via the bottom	•	•
2P and 4P DX³ RCBOs – protection of outgoing lines	•	•
1P, 2P, 3P and 4P DX³ circuit breakers – 1 module/pole	•	•
1P, 2P, 3P and 4P DX³ circuit breakers – 1.5 modules/pole		•



HX³ IS 223 125 and 400 A distribution blocks can be mounted in IS 233 and IS 333 enclosures. The service rating of these functional units will still be IS 223. If faceplates are fitted to an IS 333 enclosure, you must also use fixing lugs Cat.No 4 046 79 (see page 19).

IS 223 DISTRIBUTION BLOCKS AND BASES

VX³ IS BASES FOR DPX³ AND DPX³

These bases are used for mounting and automatically connect DPX³ 160/250 and DPX 630 circuit breakers on the column chassis. They are available for three and four-pole MCCBs. MCCBs are installed on their base in horizontal position.

Support bases for DPX ³			
MCCB	DPX ³ 160	DPX ³ 250	DPX 630
3P	4 046 10	4 046 12	4 046 16
4P	4 046 11	4 046 13	4 046 17

The base is the same for MCCBs with or without residual current protection.

SPECIAL FACEPLATES

The HX³ IS 125 and 400 A distribution blocks or the VX³ IS bases for DPX³ and DPX 630 require the use of special faceplates.

The choice of faceplate will depend on the type of distribution block or circuit breaker, and whether or not it has an accessory such as a motor-driven control on the front or a rotary handle.

Special IS 223/233 faceplates			
	Equipment	Faceplate	Height (mm)
HX ³ IS	125 A	4 046 75	200
	400 A	4 046 74	300
DPX ³ 160/250	With no accessory	4 046 70	200
	With rotary handle or motor-driven ctrl	4 046 72	200
DPX 630	With no accessory	4 046 71	300
	With rotary handle or motor-driven ctrl	4 046 73	300

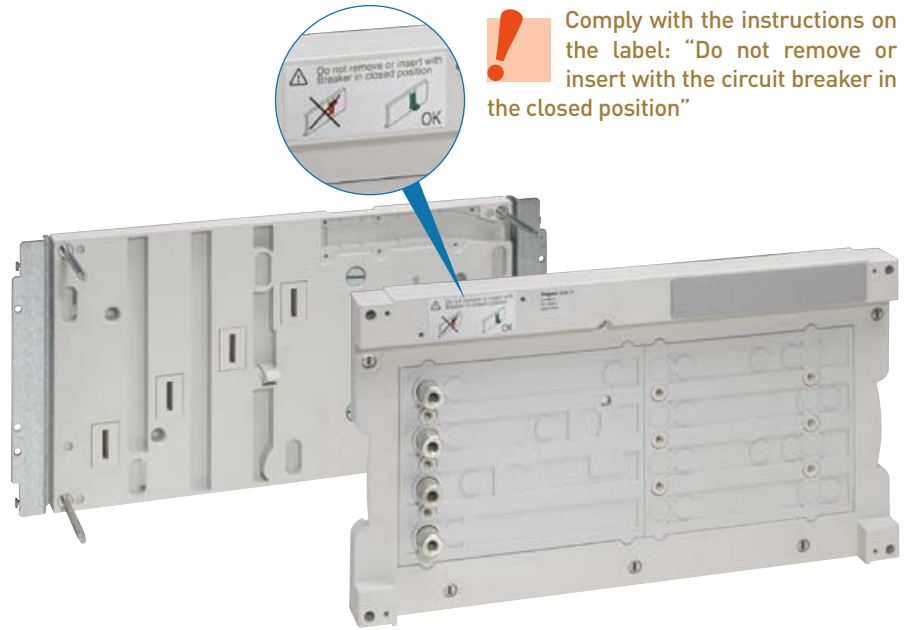

! Comply with the instructions on the label: "Do not remove or insert with the circuit breaker in the closed position"

The bases for MCCBs are made up of two parts:
 - a fixed part which snaps onto the column chassis
 - a movable part on which the circuit breaker is attached, which plugs into the fixed part



UNIVERSAL BASE

This base can be used to install any equipment, which do not require a special VX³ base: for example a power contactor. The base can take currents up to 630 A and has four connection terminals.

The faceplate to be combined with this base is a 300 mm high screw-in faceplate (Cat.No 0 209 44) with hinges (Cat.No 0 209 59).

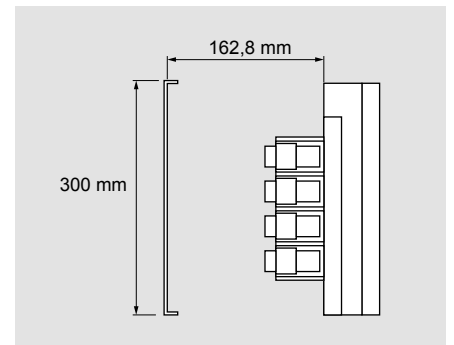

Space available under faceplate.

INSTALLING HX³ IS 125 A DISTRIBUTION BLOCKS

1 INSTALLING CONNECTION MODULES

The connection module is easy to install and requires no special tools

■ 1 module per pole MCBs

The connection module is fitted via the rear of the circuit breaker.

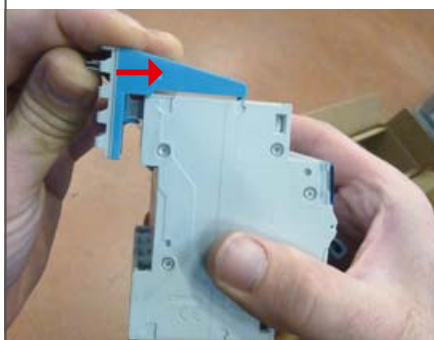

Position the upper part of the connection module (marked "Max 80") on top of the circuit breaker then push it forward to engage the module pin in the MCB. This device ensures correct contact pressure. Do the same for the other poles.

The connection module comes in four colours corresponding to the four poles on the row distribution block.

Blue	Brown	Grey	Black
Neutral	Phase 1	Phase 2	Phase 3

This allows the desired phase to be selected. It is thus very easy to balance the phases on the complete row.



4-POLE CIRCUIT BREAKER EQUIPPED WITH ITS 4 CONNECTION MODULES

2 INSTALLING MCBS ON THE DISTRIBUTION BLOCK



Lift up the clips on the top of the MCB.



Position the circuit breaker on the rail by first pushing in the bottom of the appliance, then exerting pressure on the top to push the circuit breaker into position. The product is then automatically connected to the distribution block.

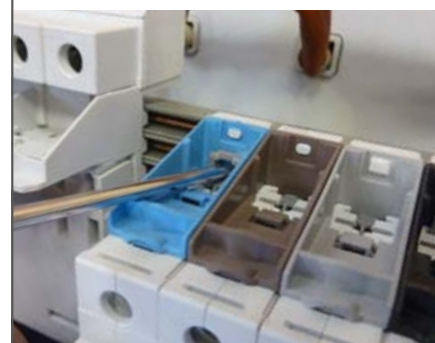

Installation is complete once all the clips are in the locked position.

IS 223 DISTRIBUTION BLOCKS AND BASES

3 MOUNTING THE DISTRIBUTION BLOCK ON THE VX³ IS CHASSIS

Before installation on the IS chassis, the fixed part of the row distribution block must first be attached.



Positioning is based on the same principle as for a standard XL³ plate, thanks to lugs which hook onto the functional uprights.



The 4 guide pins make it easier to position the movable part on the fixed part, as it ensures that the connector pins are perfectly adjusted.



Fix the movable part to the fixed part with the screws supplied.



Then secure the fixed part using the screws supplied with the row distribution block.



i This step can be performed before installing the circuit breakers on the distribution block.

+ Modular devices can be added or removed, even with the HX³ distribution block powered up, once the circuit is off-load.

! The power supply module for the HX³ IS 125 A row distribution block is exclusively reserved for supplying the distribution block bars. It cannot take any modular equipment and must never be dismantled as it contains live parts.

INSTALLING HX³ IS 400 A DISTRIBUTION BLOCKS

1 MOUNTING THE DISTRIBUTION BLOCK ON THE VX³ IS CHASSIS

The HX³ IS 400 A distribution block consists of a fixed part and a movable part.



Place the fixed part in position and fix it on the IS chassis functional uprights.



Insert the movable part in the fixed part with the aid of the guide pins.



Complete installation by securing the movable part to the fixed part with the two screws supplied.

2 MOUNTING A DPX³

Circuit breakers are mounted on the VX³ IS 400 A distribution block using support bases.



Support bases for DPX³ consist of a fixed part, a movable part, an anti-withdrawal kit and two terminal shields. They enable screwless connection of a DPX³ 160 or 250 (when off-load) to the row distribution block with the voltage present.

A) MOUNTING THE CIRCUIT BREAKER ON THE BASE



Install the movable part of the base, by inserting the conductive parts into the upstream terminals of the DPX³ circuit breaker.

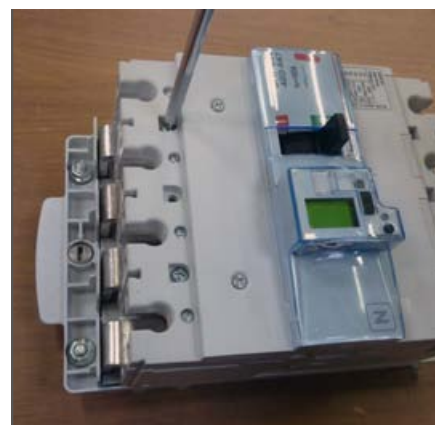

Secure the appliance to the base using the fixing screws supplied with the DPX³.



Make the upstream electrical connections with the screws supplied with the circuit breaker (no. 4 Allen key, tightening torque 7 N·m).

! When mounting a DPX³ 160 circuit breaker, first remove its own upstream cage terminals [see p. 31].

IS 223 DISTRIBUTION BLOCKS AND BASES

B) INSTALLING THE ANTI-WITHDRAWAL KIT

The anti-withdrawal kit prevents a circuit breaker being withdrawn in the closed position.



Insert the spring...



...then assemble the two parts of the kit.

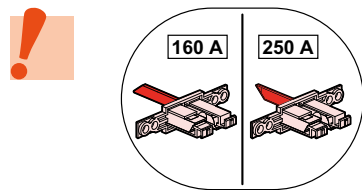

Fix the kit at the rear of the movable part of the support base with the two screws supplied (tightening torque 1 N·m).

C) POSITIONING THE TERMINAL SHIELDS



Engage the rear part of the terminal shield then push down the terminal shield at the front.



Lock the terminal shield by inserting the 2 sealed caps.

i For the downstream connection of the DPX³ circuit breaker, remove the downstream terminal shield.

D) MOUNTING THE DPX³ ON THE DISTRIBUTION BLOCK

The DPX³ equipped with a support base can be installed on the 400 A row distribution block with the voltage present.



Put the fixed part of the support base on the row distribution block.



It is locked automatically.

3 INSTALLING SUPPORT BASES FOR DX³



Guide pins make it easier to insert the circuit breaker equipped with the movable part.



Never mount the movable part on the fixed part before installing the circuit breaker.



Complete installation of the DPX³ by locking the 1/4 turn screws above and below the circuit breaker.

Installation of MCBs on the HX³ IS 400 A distribution block requires the use of support bases for DX³. They lift MCBs to the same height as DPX³, meaning they can be installed together on the same row.

A) MOUNTING 1 MODULE PER POLE DX³ MCBs ON A PLUG-IN BASE

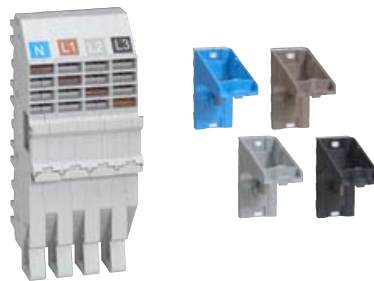

Plug-in bases are supplied complete with the corresponding connectors.



Installing connectors on the circuit breakers is identical to the explanations given for the HX³ IS 125 A distribution block. (see p. 25)



Complete installation of the support base by closing the locking levers. Once locked onto the distribution block, the support base allows the circuit breaker to be installed in the same way as on a standard DIN rail.



New circuit breakers can be added with the voltage present as long as the panel is off-load (circuit breaker in open position), like all products in the IS range.



Install the HX³ support base on the HX³ IS 400 A row distribution block.

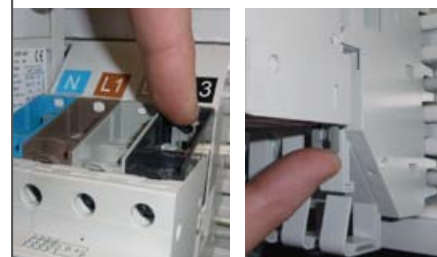

The circuit breaker is correctly installed once it is locked onto the rail.

B) MOUNTING 1 OR 1.5 MODULES PER POLE DX³ MCBs ON WIRED BASE



Pre-wired bases require a specific order of operations when mounting DX³ MCBs. To prevent any risk of contact with live parts, the wires must be connected to the circuit breaker before installing the base on the distribution block.

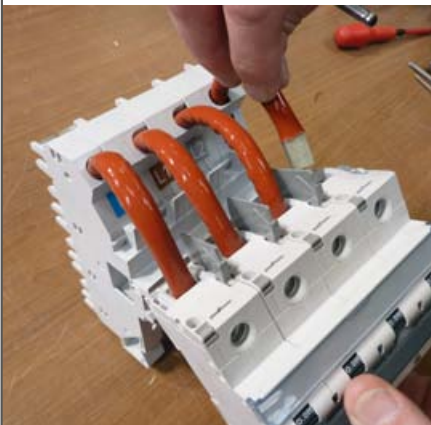

Connect the wires in the circuit breaker without installing it on the "rail" of the support base.

Recommended tightening torque:
 2.5 N·m for DX³ with 1 module/pole
 5.5 N·m for DX³ with 1.5 modules/pole



While holding the circuit breaker with one hand, install the base on the HX³ IS 400 A row distribution block and activate the locking levers.

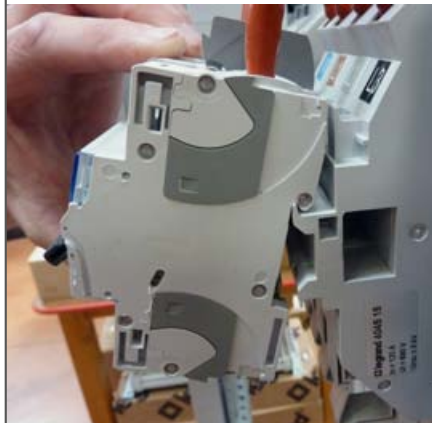

Engage the MCB in the same way as onto a standard DIN rail.

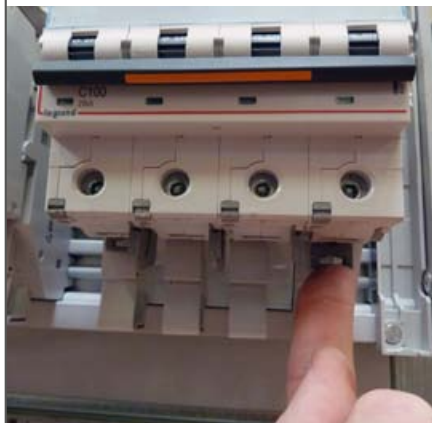

Complete installation by locking the circuit breaker clips.

4 INSTALLING THE FACEPLATE



The faceplate is a hinged faceplate with a DIN window.



INSTALLING VX³ IS 223 BASES

Example of mounting a DPX³ 160 without motor-driven control or rotary handle.

1 PREPARING THE CIRCUIT BREAKER

The circuit breaker must be equipped with the anti-withdrawal kit (supplied with the base), before to be placed on the movable part of the base. The upstream cage terminals of the DPX³ 160 circuit breakers must be removed.

The anti-withdrawal kit prevents withdrawal and insertion of the MCCB in «closed» position.



Push in the two brass inserts.



Insert the black bracket.



Fix the latch with the two screws supplied (tightening torque 1 N·m).



Take out the upstream rear blanking plates.

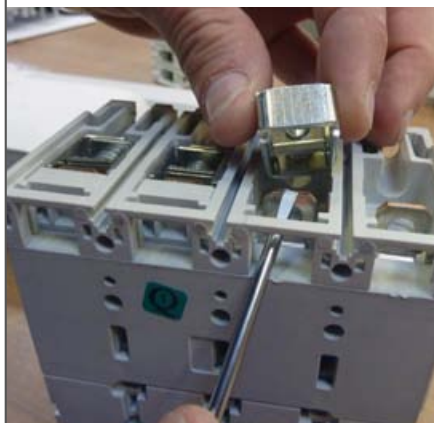

Take out the upstream cage terminals.

! If the circuit breaker needs to be equipped with auxiliaries, these must be installed before the appliance is placed on the HX³ base (see p. 35).

+ The circuit breaker can also be equipped with a rotary handle or motor-driven control on the front (see p. 34).

2 MOUNTING THE CIRCUIT BREAKER ON THE MOVABLE PART OF THE BASE



Place the circuit breaker on the movable part of the base.



Fix the DPX³ using the screws supplied with the circuit breaker (tightening torque 1 N·m).

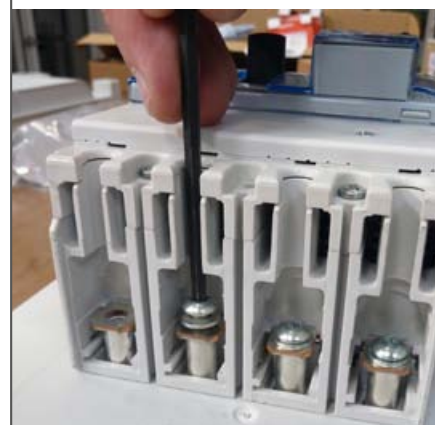

Tighten the upstream electrical connections using the eight (or six) screws supplied with the circuit breaker (tightening torque 7 N·m).

3 INSTALLING THE UPSTREAM SEALED TERMINAL SHIELD

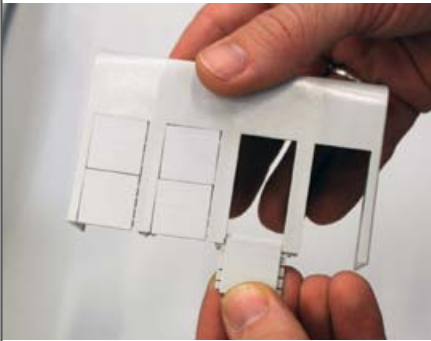

For rear connection, the terminal shields must be filled in with the blanking plates supplied.



Position the terminal shield.

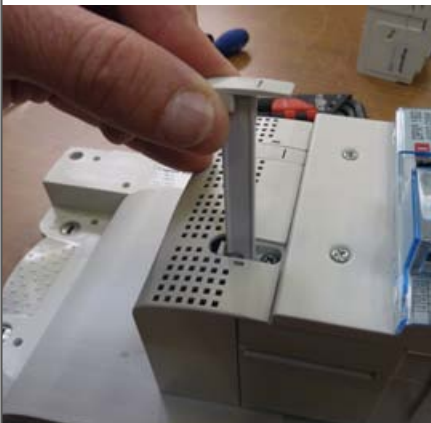

Lock the terminal shield by inserting the two sealed locking caps.

4 MOUNTING THE BASE ON THE VX³ IS COLUMN CHASSIS

The fixed part of the base hooks onto the uprights like an ordinary plate thanks to its metal lugs.



The fixed part of the VX³ base is finally secured on the IS chassis uprights by using the two screws supplied (don't forget to insert the two clip-nuts in the uprights first).



This ¼ turn lock, in the middle of the fixed part, prevents the base being removed while the circuit breaker is in place.



5 UPSTREAM CONNECTION OF THE CIRCUIT BREAKER



Insert the movable part equipped with the circuit breaker in the fixed part using the four metal guide pins.



The movable part is locked onto the fixed part using the ¼ turn screws (two on each side).



! The circuit breaker must always be in the "OPEN" position before inserting the base!

6 DOWNSTREAM CONNECTION OF THE CIRCUIT BREAKER



Connect the cables in the circuit breaker downstream cage terminals (tightening torque 8 N·m).



Install the downstream terminal shield, and insert both locking caps (in this photo, the circuit breaker has a rotary handle).



 Connecting outputs to Viking 3 terminals allow obtaining of 4b form of separation.

7 INSTALLING THE PIVOTING FACEPLATE



The faceplates are supplied with two packs of accessories. One contains two DIN rails with screws, which can be used to mount modular devices on the front panel. The other contains the hinges and screws for fixing the faceplate to the faceplate support as well as the 1/4 turn lock with its adjusting nut and double bar key.



After screwing both hinges onto the faceplate as indicated in the instructions, fix the assembly on the faceplate support upright using the two nuts supplied.

8 MOUNTING A MEASURING DEVICE ON THE FRONT PANEL



The faceplate is pre-cut to allow installation of a rotary handle or motor-driven control on the front.



The faceplate allows a modular device, such as a measuring device, to be installed (see page 43).



Signalling units can also be installed.

VX³ IS 233 BASES

IS 233 bases combined with the column chassis can be used to create an IS 233 enclosure very quickly, meaning that:

- **During operation**, it is possible to isolate and lock out a functional unit (FU) individually but it is not possible to conduct tests on the auxiliary circuits (especially electronic control boxes).
- **During maintenance**, it is possible to lock out each FU without doing anything to the connection.
- **During upgrading**, it is possible to add any type of FU in an unequipped slot.

For this reason, each IS 233 base is equipped with screwless connections for connections upstream and downstream of the main circuit.

PRODUCT SELECTION

BASES FOR MCCBs

Bases should be selected according to the type of appliance you wish to install in the functional unit.

MCCB	DPX ³ 160	DPX ³ 250	DPX 630
3P	4 046 20	4 046 22	4 046 26
4P	4 046 21	4 046 23	4 046 27
3P elcbs			4 046 36
4P elcbs	4 046 31	4 046 33	4 046 37

Each IS 233 base consists of:

- 1 fixed part
- 1 movable part
- 2 fixing brackets and screws
- 2 terminal shields
- 1 kit to prevent withdrawal of the closed circuit breaker



IS 233 bases
for DPX³ 160

SPECIAL FACEPLATES

If necessary, finish installation with the appropriate faceplate which should be selected from the table below.

MCCB	DPX ³ 160/250	DPX 630
W/o rotary handle or motor-driven ctrl	4 046 70	4 046 71
With rotary handle or motor-driven ctrl	4 046 72	4 046 73

UNIVERSAL BASE

This base can be used to install appliances which do not have a special VX³ base: for example a power contactor. The base can take currents as high as 630 A and has eight connection terminals. The faceplate to be combined with this base is a 300 mm high screw-in faceplate (Cat.No 0 209 44) with hinges (Cat.No 0 209 59).

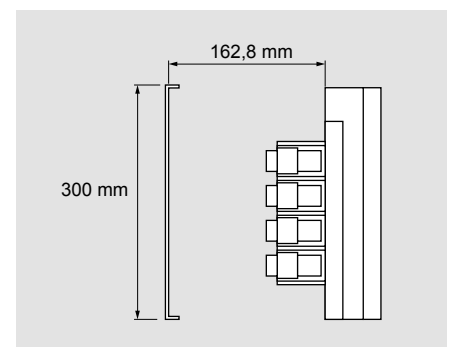

Space available under faceplate.

INSTALLATION

Example of mounting a DPX³ 160 thermal-magnetic MCCB (160 A 4P) Cat.No 4 201 37 equipped with a motor-driven control on the front Cat.No 4 210 61.

1 PREPARING THE CIRCUIT BREAKER

The circuit breaker must be equipped with the anti-withdrawal kit supplied with the base and the cage terminals must be removed before placing it on the movable part of the base.



Anti-withdrawal kit.

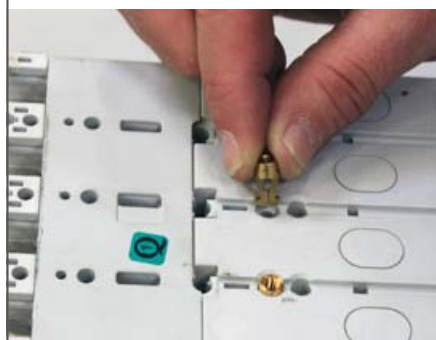

Push in the two brass inserts.



Insert the black bracket and the latch, the assembly is held in place with the two screws supplied. Tightening torque 1 N·m.



Remove the upstream and downstream rear blanking plates.

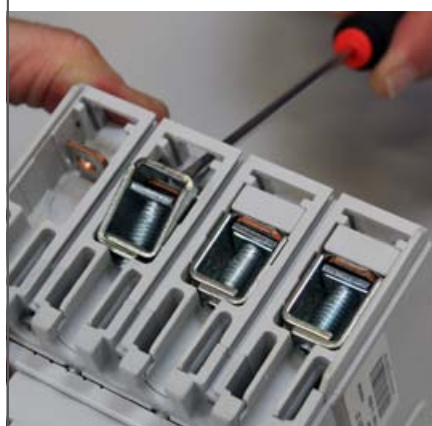

Remove the upstream and downstream cage terminals.

2 MOUNTING AUXILIARIES

The circuit breaker can be equipped with auxiliaries (shunt trip, undervoltage release, auxiliary contacts or fault signal).



After connecting the wires to the auxiliary terminals, bring them out at the back of the appliance through the gaps left on purpose.



When installing the circuit breaker, space is left on the base to allow the wires to exit.

3 INSTALLING THE MOTOR-DRIVEN CONTROL



Pierce the circuit breaker cover as indicated in the instructions.



Fix the motor-driven control base unit using the pre-drilled holes.

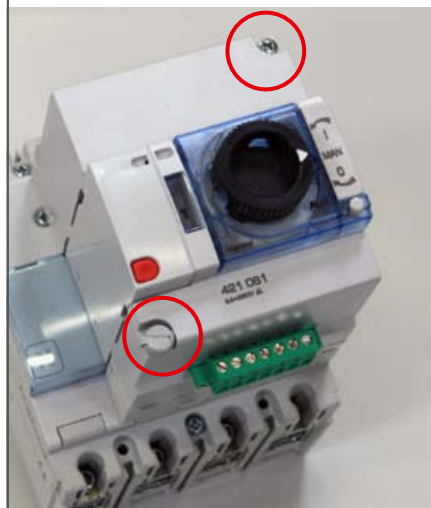

Fix the motor onto its base using the two screws at diagonals.

 The motor-driven control is supplied with a sealable screw cover to prevent the motor being dismantled.

4 MOUNTING THE CIRCUIT BREAKER ON THE MOVABLE PART OF THE BASE



Place the appliance on the base, then secure it with the screws supplied with the circuit breaker (tightening torque 1 N·m).



Tighten the upstream and downstream electrical connections using the eight (or six) screws supplied with the circuit breaker. Apply a tightening torque of 7 N·m.

5 INSTALLING THE SEALED TERMINAL SHIELDS

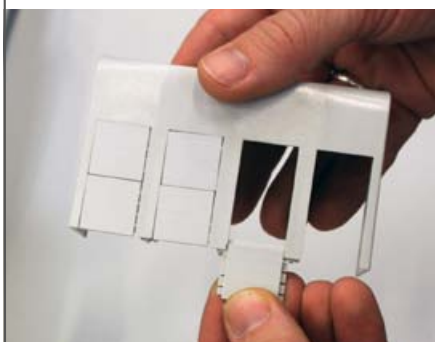

For rear connection, terminal shields must be finished with the blanking plates supplied.



Once the terminal shields are in place, they are locked by inserting all four locking caps.

6 MOUNTING THE BASE ON THE IS COLUMN CHASSIS



This part hooks onto the uprights just like an ordinary plate with its metal lugs.



The fixed part of the base is finally secured on the VX³ IS chassis uprights using the two screws supplied (don't forget to insert the two clip-nuts in the uprights first).



The fixed part is locked with 1/4 turn screws.



The movable part is inserted in the fixed part using the four metal guide pins.

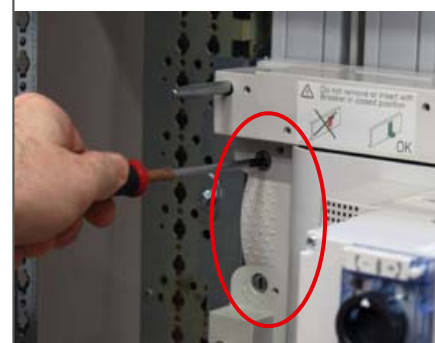

The movable part is locked onto the fixed part using the 1/4 turn screws (two on each side).

7 INSTALLING THE PIVOTING FACEPLATE



The faceplates are supplied with two packs of accessories. One contains two DIN rails with screws, which can be used to mount modular devices on the front panel. The other contains hinges and screws for fixing the faceplate to the faceplate support as well as the 1/4 turn lock with its adjusting nut and double bar key.



The faceplate is common to circuit breakers equipped with a rotary handle or motor-driven control. When installing a motor-driven control it will be necessary to break the specially provided cut-out.



After screwing both hinges onto the faceplate as indicated in the instructions, the assembly is fixed on the faceplate support upright using both nuts supplied.



Depending on the type of circuit breaker used, the front of the motor-driven control will vary in width, so it may be necessary to fill up the empty space with a modular blanking plate.

8 MOUNTING A MEASURING DEVICE ON THE FRONT PANEL

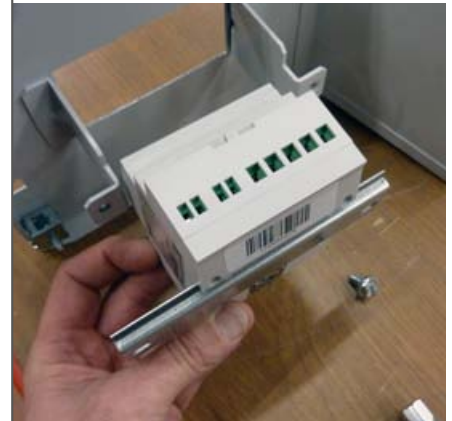

Open the pre-cut window in the faceplate, then install the modular device on the DIN rail.



Fix the assembly on the faceplate with the screws supplied.

9 INSTALLING THE MODULE FOR CONNECTING THE AUXILIARIES

IS 233 bases can take an optional module Cat.No 4 046 59 to connect the auxiliaries.



Remove the plastic blanking plate from the movable part of the VX³ IS base.

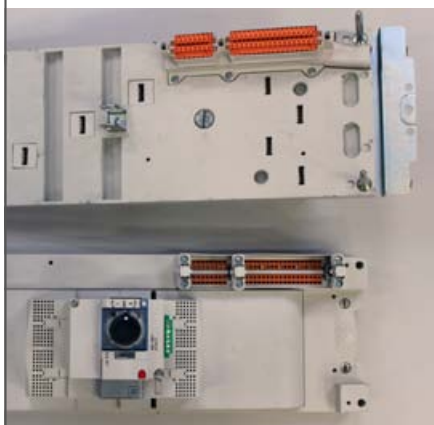

Place the male part of the connection module on the fixed part of the VX³ IS base and the female part on the movable part using the screws supplied.

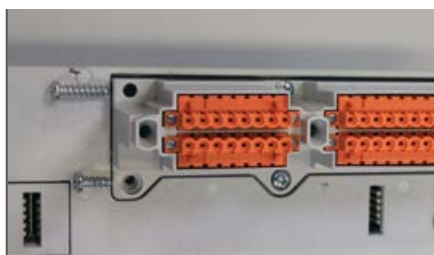

Use six screws for the fixed part, three large ones on the outer edge and three small ones on the inside.



For the movable part, the female part of the connection module is fixed at the rear with six small screws (tightening torque 2.5 N·m).

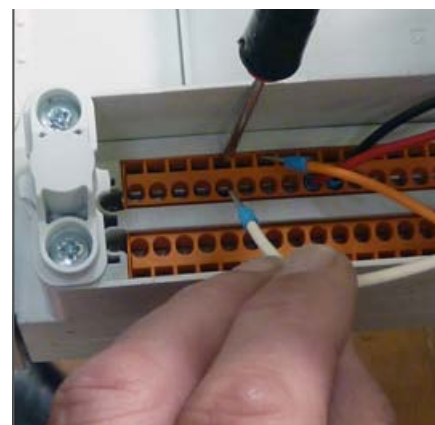

Connect the wires to the module for auxiliary circuits on the movable part of the base. The connection module has screwless terminals and the use of Starfix ferrules is recommended for wiring.

The module has terminals for connecting all the circuits of the MCCBs equipped with all their auxiliaries, rotary handles, motor-driven controls and RCDs. Dedicated slots are also available for Legrand supervision modules. The preferred wiring diagram (included in the instructions) is shown below.

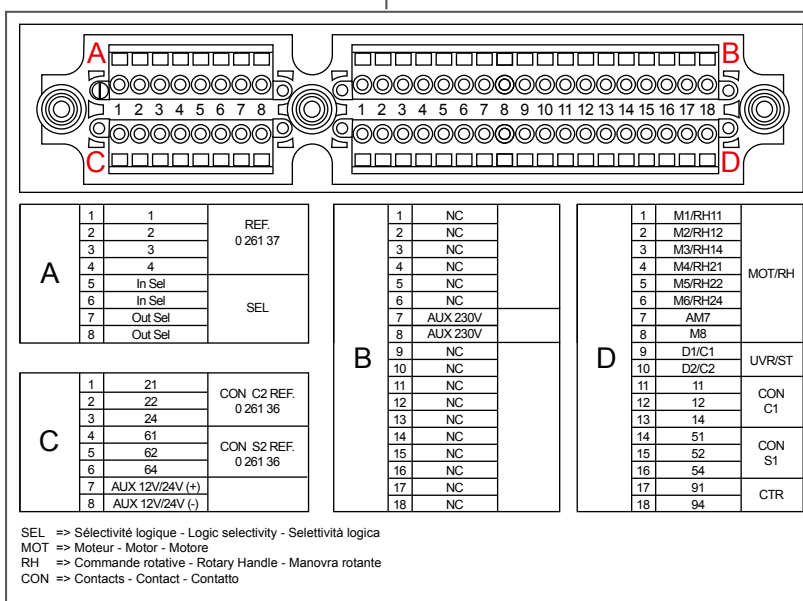

IS 233 BASES

10 DOWNSTREAM CONNECTION



The IS 233 bases are connected downstream using bar ends with two drill holes for M8 screws, enabling connection via bars or lugs.

11 FORMS



By default, spare compartments must be fitted with dividers (Cat.No 4 046 89) which can achieve form 3b, the minimum level required for IS 233.

To achieve form 4b, you need to add rear partitioning kits Cat. Nos. 4 046 87 and 4 046 88.



To make them more compact, these kits are supplied flat-packed, and therefore need to be folded into a U shape.

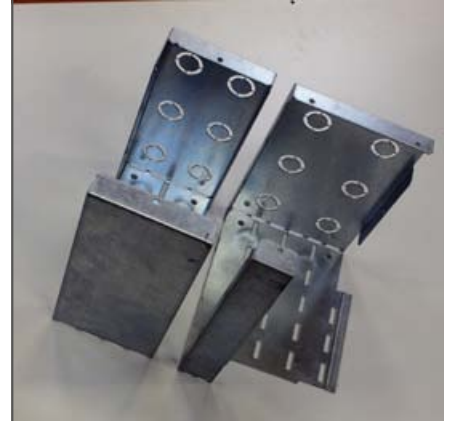

If more space is needed for connection, the extension supplied can be used.



To fix the kit at the rear of the chassis, first insert the two clip-nuts.



Insert the kit in the side partitioning slot of the chassis, then secure it with the four screws supplied.



If necessary, fix the extension on the part that has already been mounted using the four screws supplied.



The compartment rear cover consists of three insulating parts and four caps which can be cut out to allow the conductors to pass through.



Screw in the middle panel using the four screws supplied.



Push in the cable entry caps and screw in the two side panels using the four screws supplied.



Equipped in this way, the IS system ensures compliance with the requirements of 4b form of separation.

VX³ IS 333 BASES

IS 333 bases combined with the column chassis can be used to create an IS 333 enclosure very quickly, meaning that:

- **During operation** : functional unit (FU) lockout with the possibility of conducting tests on the auxiliary circuits is guaranteed.
- **During maintenance** : it is possible to lock out each FU without doing anything to the connection.
- **During upgrading** : it is possible to add any type of FU in an unequipped slot.

To do this, each IS 333 base is equipped with an automatic upstream and downstream connection system for the main circuit and a connection module for the auxiliaries which can be disconnected.

PRODUCT SELECTION

BASES FOR MCCBs

Bases should be selected according to the type of equipment you wish to install in the functional unit.

MCCB	DPX ³ 160	DPX ³ 250	DPX 630
3P	4 046 40	4 046 42	4 046 46
4P	4 046 41	4 046 43	4 046 47
3P eclbs.			4 046 56
4P eclbs.	4 046 51	4 046 53	4 046 57

Each IS 333 base consists of:

- 1 fixed part with runners
- 1 movable part (tray)
- 1 connection module for the auxiliaries
- 2 fixing brackets and screws
- 2 terminal shields
- 1 kit to prevent withdrawal of the closed circuit breaker

SPECIAL FACEPLATES

If necessary, finish installation with the appropriate faceplate which should be selected from the table below.

MCCB	DPX ³ 160/250	DPX 630
W/o rotary handle or motor-driven ctrl	4 046 80	4 046 81
With rotary handle or motor-driven ctrl	4 046 82	4 046 83

UNIVERSAL BASE

This base can be used to install appliances which do not have a special VX³ base: for example a power contactor.

The base can take currents as high as 630 A and has eight connection terminals. In this case, the faceplate is included with the catalogue item.

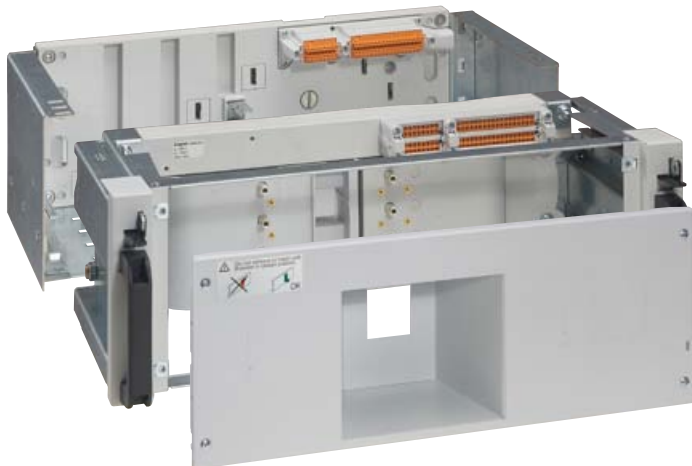

VX³ IS 333 base for DPX³ 250 and special faceplate (to be ordered separately)

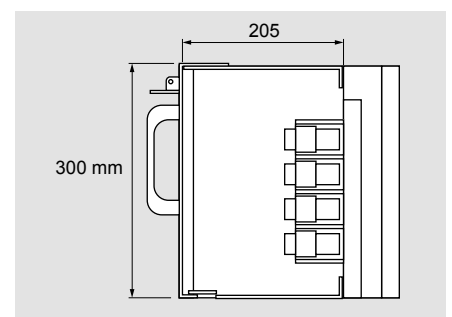

Space available under faceplate.

! The IS 333 distribution system does not allow doors to be fitted to enclosures.

INSTALLATION

Example of mounting an electronic 4P DPX³ 250 without a motor-driven control or rotary handle.

1 PREPARING THE CIRCUIT BREAKER

The circuit breaker must be equipped with the anti-withdrawal kit (supplied with the base) before to be placed on the movable part of the base.



The anti-withdrawal kit consists of a bracket and a latch with its fixing accessories.

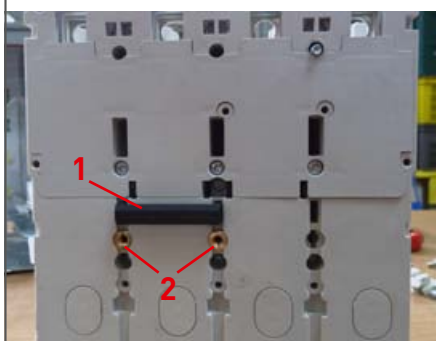

Insert the black bracket (1), then push in the two brass inserts (2)



To finish, fix the latch with the two screws included in the pack. Tightening torque 1 N·m.

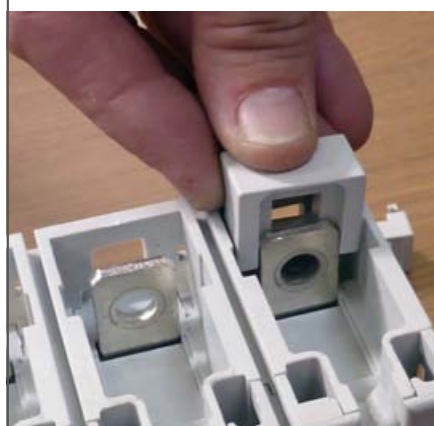

The upstream and downstream connection plates must be fitted with the plastic spacers supplied with the circuit breaker.

2 MOUNTING THE AUXILIARIES

The circuit breaker can be equipped with auxiliaries (shunt trip, undervoltage release, auxiliary contacts or fault signal) or a motor-driven control.



After connecting the wires to the auxiliary terminals, bring them out at the back of the appliance through the gaps left on purpose.

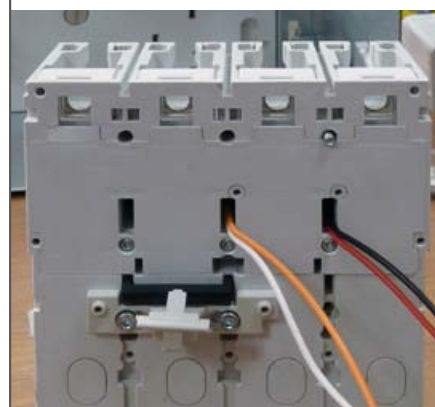

When installing the circuit breaker, space is left on the base to allow the wires to exit.

IS 233 BASES

3 MOUNTING THE CIRCUIT BREAKER ON THE BASE

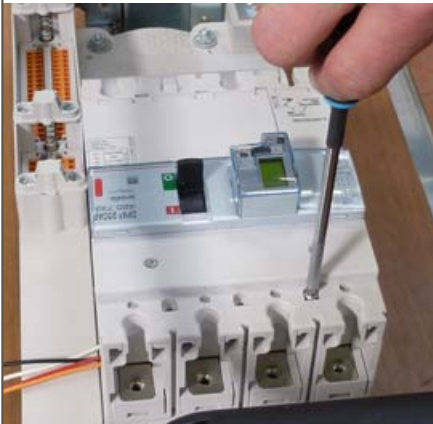

Place the device in the drawer and secure it with the two screws supplied with the circuit breaker (tightening torque 1 N·m).



Tighten the upstream and downstream electrical connections using the eight (or six) screws supplied with the circuit breaker. Apply a tightening torque of 7 N·m.



Install the sealed terminal shields.

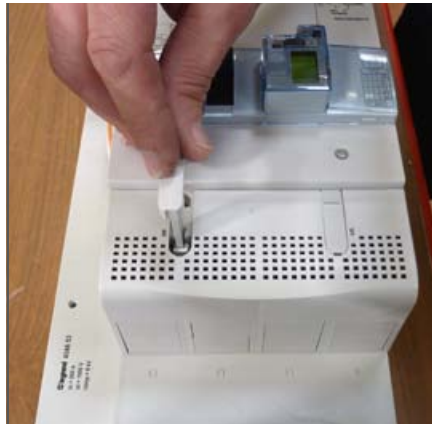

Insert the locking caps.

4 CONNECTING THE AUXILIARY CIRCUITS

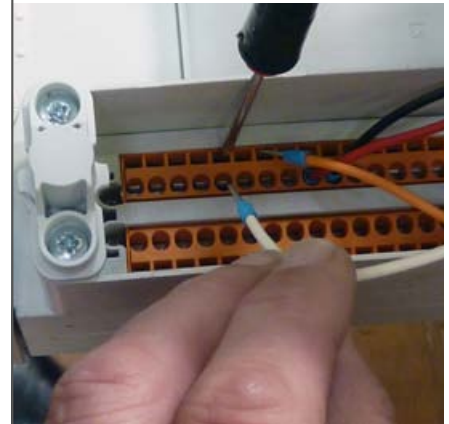

Once the MCCB is in position, connect the wires to the module for auxiliary circuits, on the movable part of the base. The connection module has screwless terminals and the use of Starfix ferrules is recommended for wiring. The module has terminals for connecting all the circuits of appliances equipped with all their auxiliaries, rotary handles, motor-driven controls and RCDs. Dedicated slots are also available for Legrand supervision modules. The preferred wiring diagram (included in the instructions) is shown below.

Terminal	Function	Reference
1	1	REF. 0 261 37
2	2	
3	3	
4	4	SEL
5	In Sel	
6	In Sel	
7	Out Sel	
8	Out Sel	

Terminal	Function	Reference
1	21	CON C2 REF. 0 261 36
2	22	
3	24	
4	61	CON S2 REF. 0 261 36
5	62	
6	64	
7	AUX 12V/24V (+)	
8	AUX 12V/24V (-)	

Terminal	Function	Reference
1	NC	
2	NC	
3	NC	
4	NC	
5	NC	
6	NC	
7	AUX 230V	
8	AUX 230V	
9	NC	
10	NC	
11	NC	
12	NC	
13	NC	
14	NC	
15	NC	
16	NC	
17	NC	
18	NC	

Terminal	Function	Reference
1	M1/RH11	MOT/RH
2	M2/RH12	
3	M3/RH14	
4	M4/RH21	
5	M5/RH22	
6	M6/RH24	
7	AM7	UVR/ST
8	M8	
9	D1/C1	CON C1
10	D2/C2	
11	11	CON S1
12	12	
13	14	
14	51	
15	52	CON S1
16	54	
17	91	CTR
18	94	

SEL => Sélectivité logique - Logic selectivity - Selettività logica
 MOT => Moteur - Motor - Motore
 RH => Commande rotative - Rotary Handle - Manovra rotante
 CON => Contacts - Contact - Contatto

5 MOUNTING THE FACEPLATE



The pack contains a faceplate and two kits of accessories.

The first kit contains the DIN rail and the screws for mounting modular devices on the front and the second contains the cage nuts and screws for fixing the faceplate on the tray.



Position the faceplate and tighten the four screws.

6 MOUNTING A MODULAR DEVICE ON THE FACEPLATE



Install the modular device on the DIN rail.



Insert the four cage nuts and screws supplied with the faceplate.



Fix the assembly on the faceplate with the screws supplied.



Depending on the circuit breaker used, adjust the size of the window using the specially provided cut-outs.



Once assembly is complete, the measuring device can be wired up to the tray connector in the same way as for the circuit breaker auxiliaries using the free terminals on connector B.

7 MOUNTING THE FIXED PART ON THE VX³ COLUMN CHASSIS



Pins ensure that the base is positioned in exactly the right position.

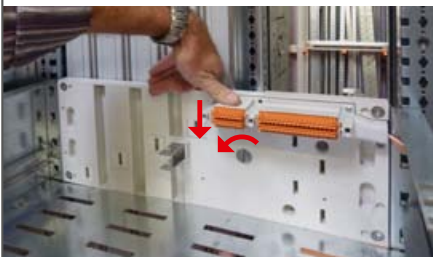

Check that the base is in the correct position by applying gentle downward pressure and then lock the ¼ turn screw to hold the base in position.

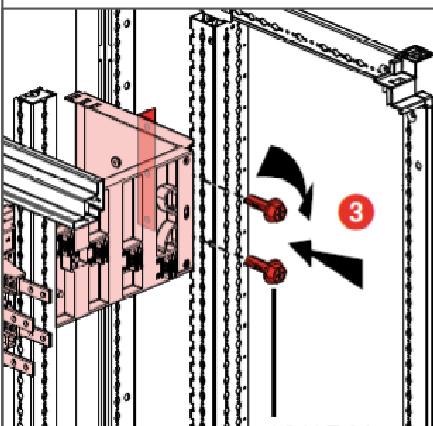

Fix the base to the functional uprights (10 to 15 N·m) then to the uprights on the front of the structure using brackets (4 to 6 N·m).



8 CONNECTING THE AUXILIARY CIRCUITS TO THE FIXED PART

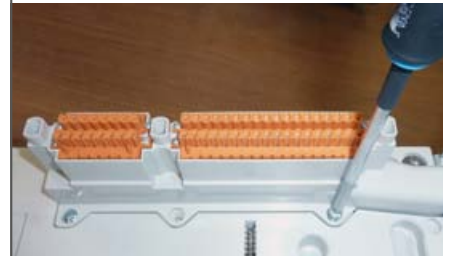

Remove the connectors.

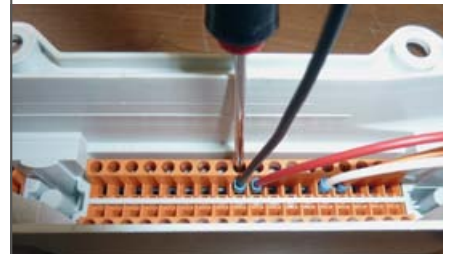

Connect the outgoing lines for the auxiliary circuits equipped with Starfix ferrules, using the same wiring diagram as for the movable part.



Cut out the blanking plate so the cables can be fed through, then use a cable entry cap as shown in the picture.



Fix the connection module for the auxiliary circuits back on the base.

9 INSERTING THE TRAY IN THE BASE



Hold the tray against the fixed base and push as far as the locking hole. The tray is then in the removed position, with the upstream and downstream main contacts disconnected and auxiliary contacts disconnected.



To fully insert the tray, apply pressure to both locking levers and push in the tray.



Tray in "inserted" position



The three tray positions: "inserted", "test", "removed", are indicated with a coloured LED

Red: tray inserted (power and auxiliaries)

Yellow: tray in test position (only the auxiliaries connected)

Green: tray removed (all circuits isolated)



The tray can be locked out in each of the three positions with an ordinary padlock inserted in the locking lever. There is space available on each of the two levers.



 Fixing lugs Cat. No. 4 046 79 can be used to mount solid faceplates for spare compartments and modular faceplates for HX³ IS 223 125 and 400 A distribution blocks (see mounting on p. 19).

10 DOWNSTREAM CONNECTION



IS 333 bases are connected downstream using bar ends with two drill holes for M8 screws, enabling connection via bars or lugs.

11 FORMS

 By default, spare compartments must be fitted with dividers (Cat.No 4 046 89) which can achieve 3b form as required for IS 333. To upgrade to 4b form, you need to add rear partitioning kits (Cat. Nos.4 046 87 and 4 046 88). Details of mounting are given in the IS 233 section (see p. 38).

INSTALLATION

Example of mounting a DPX 630 4P without a motor-driven control or rotary handle.

1 PREPARING THE CIRCUIT BREAKER

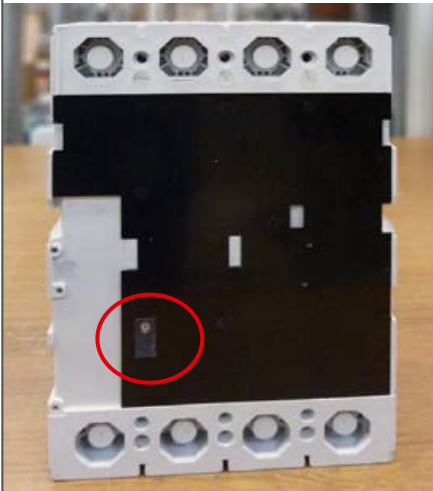

Before mounting the DPX, remove the plate at the back of the product to release the pin. This will trip the circuit breaker whenever the tray (movable part) is no longer in contact with the base (fixed part).

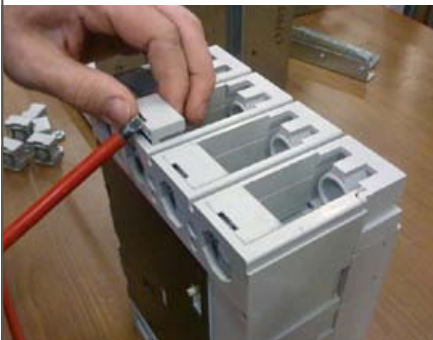

Remove the eight plastic spacers from the appliance upstream and downstream terminals.

2 MOUNTING THE CIRCUIT BREAKER ON THE BASE



Place the MCCB in the drawer.



Fix it using the four screws supplied with the circuit breaker (tightening torque: 1 N·m).

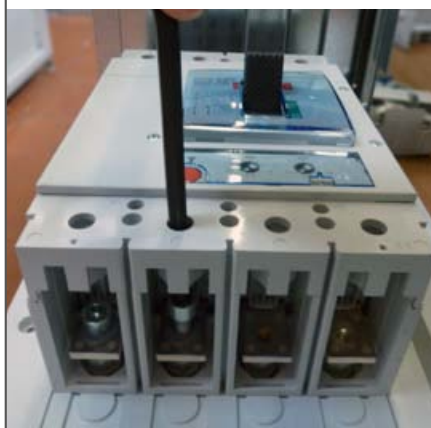

Tighten the upstream and downstream electrical connections using the eight screws supplied with the circuit breaker. Apply a tightening torque of 24 N·m.

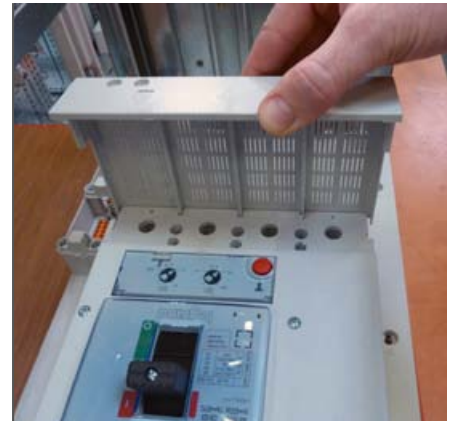

Insert the terminal shields in the MCCB.



Fix them using the screws supplied (two per terminal shield).

3 MOUNTING THE BASE AND TRAY ASSEMBLY



The base (fixed part) is inserted in the enclosure in the same way as the one on the DPX³ 250 (see page 44), except that it is locked with two ¼ turn screws.



The drawer (movable part) is inserted in the same way as the one on the DPX³ 250 (see page 45), by exerting pressure on both locking levers.

4 MOUNTING THE FACEPLATE



The faceplate is fixed with the four screws supplied.



PLUG-IN AND DRAW-OUT BASES

PLUG-IN BASES IS 222 OR IS 232

In the case of IS 222 or 232, it is of course possible to use the IS system, but DPX circuit breakers equipped with plug-in bases in combination with a form 3b can also meet these requirements.

In fact with plug-in bases:

- **During operation** : each functional unit can be shut down separately.
- **During maintenance phases** : interruption is limited to just the functional unit affected. Moreover, reinsertion will not necessarily require anything to be done to the connections.
- **For future upgrading** : simply provide one or more unequipped bases inside the panel to obtain a spare compartment that can be equipped at a later date, without having to switch off the panel. The type of unit would therefore be pre-planned and not modifiable without switching off the panel.

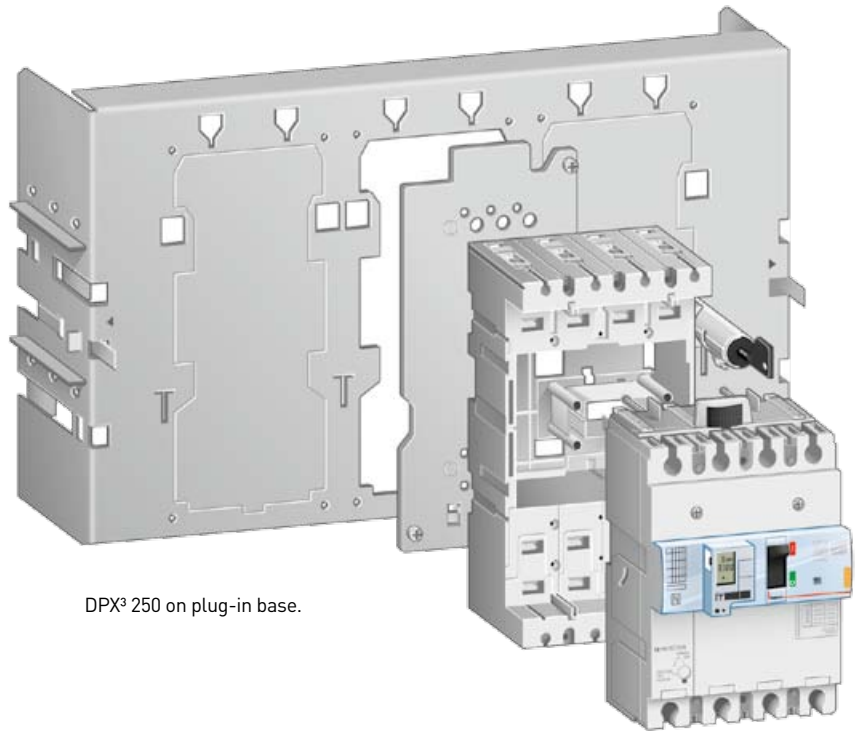

DPX³ 250 on plug-in base.



Plug-in bases are available for DPX³ 160 to DPX 630 MCCBs. For DPX 1600 MCCBs the draw-out base must be used.

DRAW-OUT BASES

IS 322 OR IS 332

Although IS 322 and 332 can be obtained when using the Legrand IS 333 system, it is also possible to use draw-out bases in combination with a 3b or 4b form.

The following applies to draw-out bases:

- **During operation** : each functional unit can be shut down separately. It is also possible to put the circuit breaker in the test position, allowing the auxiliary circuits to be tested while guaranteeing that just the functional unit affected on the power circuit is isolated.
- **During maintenance phases** : interruption is limited to just the functional unit affected. Moreover, reinsertion will not require anything to be done to the connections.
- **For future upgrading** : simply provide one or more unequipped bases inside the panel to obtain a spare compartment that can be equipped at a later date without having to switch off the panel. The type of unit would therefore normally not be modifiable without switching off the panel.

 From the DPX 250 to the DMX³ 6300, the wide choice of our draw-out bases means any type of moulded case and air circuit breaker outgoing line is suitable for this Increased Safety type.



DMX³ 2500 draw-out version.

IS LEVELS ACHIEVABLE WITH PLUG-IN AND DRAW-OUT VERSIONS

MINIMUM IS REQUIRED	MINIMUM FORM OF SEPARATION	MINIMUM WITHDRAWABILITY INDEX	PROPOSED LEGRAND SOLUTION	IS ACHIEVED	MAXIMUM FORM WITH LEGRAND SOLUTION	LEGRAND WITHDRAWABILITY INDEX
221	3b	DFF	Plug-in versions	232	4b	DDF/DDD
222	3b	DFF	Plug-in versions	232	4b	DDF/DDD
231	3b	DDD	Plug-in versions	232	4b	DDD
232	3b	DDD	Plug-in versions	232	4b	DDD
311	1	WWW	Draw-out versions	332	4b	WWW
321	3b	WWW	Draw-out versions	332	4b	WWW
322	3b	WWW	Draw-out versions	332	4b	WWW
331	3b	WWW	Draw-out versions	332	4b	WWW
332	3b	WWW	Draw-out versions	332	4b	WWW



FOLLOW US
ALSO ON

@ www.legrand.com

 www.youtube.com/legrand

 twitter.com/@legrand



World Headquarters
and International Department
87045 Limoges Cedex - France
Tel.: + 33 (0) 5 55 06 87 87
Fax: + 33 (0) 5 55 06 74 55